

Low voltage

EasyPact

15 to 400 A circuit breakers

Catalogue
2011

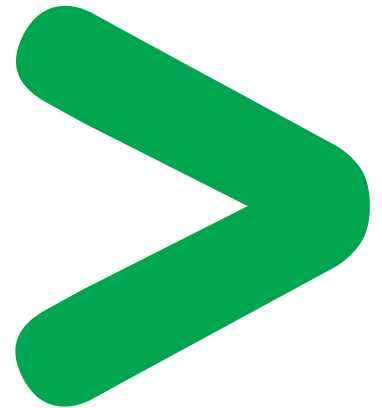

Presentation	2
--------------	---

Functions and characteristics	A-1
----------------------------------	-----

Busbars	B-1
---------	-----

Installation guide	C-1
--------------------	-----

Catalogue numbers	D-1
-------------------	-----

So easy, so simple

With just three sizes of circuit breakers, Schneider Electric's EasyPact™ system is the simple, universal solution to fit all low-voltage protection needs.

> The fixed version is particularly adapted to the OEM and Building markets, offering optimum performance at a competitive price.

> The plug-in version offers an additional function dedicated to the Marine market.

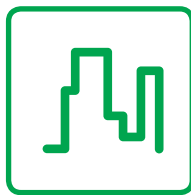

Buildings



Marine

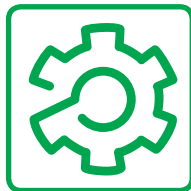

OEM



EasyPact™ range complies with worldwide standards :

- IEC 60947-2
- EN 60947-2
- JISC8201-2-1/C8201-2-2 (annex 1 and 2)
- GB 14048.2
- NEMA-AB1
- UL508 ⁽¹⁾
- CSA22-2 ⁽²⁾
- IACS for Merchant Marine

(International Association of Classification Societies: ABS, BV, CCS, DNV, GL, KRS, LR, NK, RINA)**

⁽¹⁾ Only for the 250A and 400A models

⁽²⁾ Only for the 100A and 250A models

With international certifications and approvals by independent laboratories:

ASEFA, KEMA, TILVA, TÜV, UL

And compliance to RoHS Directive

(Restriction of Hazardous Substances)

Easy to choose

EasyPact™ brings you easy solutions

- > From 15 A to 400 A
- > Up to 50 kA at 415 V
- > Up to 4 poles
- > In only three frame sizes
- > With a complete range of auxiliaries: rotary commands, auxiliaries, shunt trip, phase barrier, terminal cover, undervoltage trip

▲ Breaking capacity
Icu kA at 400/415 V AC

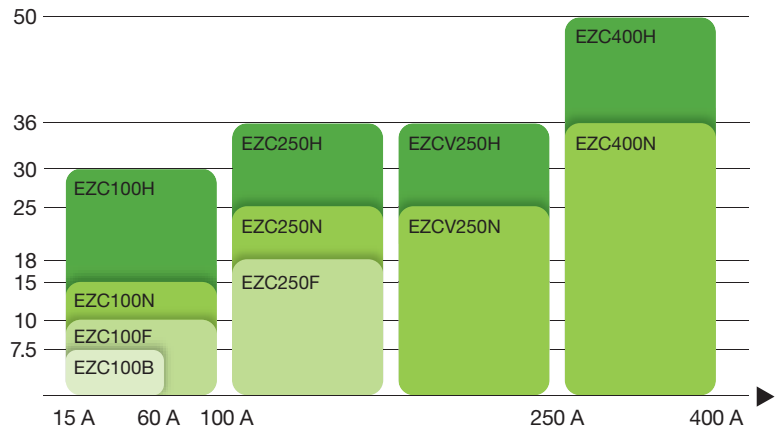

Easy to install

- > Fixed front mounting
- > Plug-in mounting
- > Front connexions
- > Bare cables connected through cable lugs, screwed inside the breaker
- > Field-installable auxiliaries and accessories
- > Built-in earth-leakage protection
- > Interchangeable MCCB and ELCB



Easy to use

- > A thermal calibration suitable for MCCB use at 50 °C without derating
- > Positive contact indication for safety and reliability
- > A smaller case optimized for tight spaces



EasyPact™:
 Build your complete solution with
Schneider Electric



Timely delivery, wherever you are

Schneider Electric offers a world-renowned logistics network capable of getting EasyPact™ products to you fast, wherever you are.

Accessories

The new **plug-in accessory** reduces installation and maintenance time.

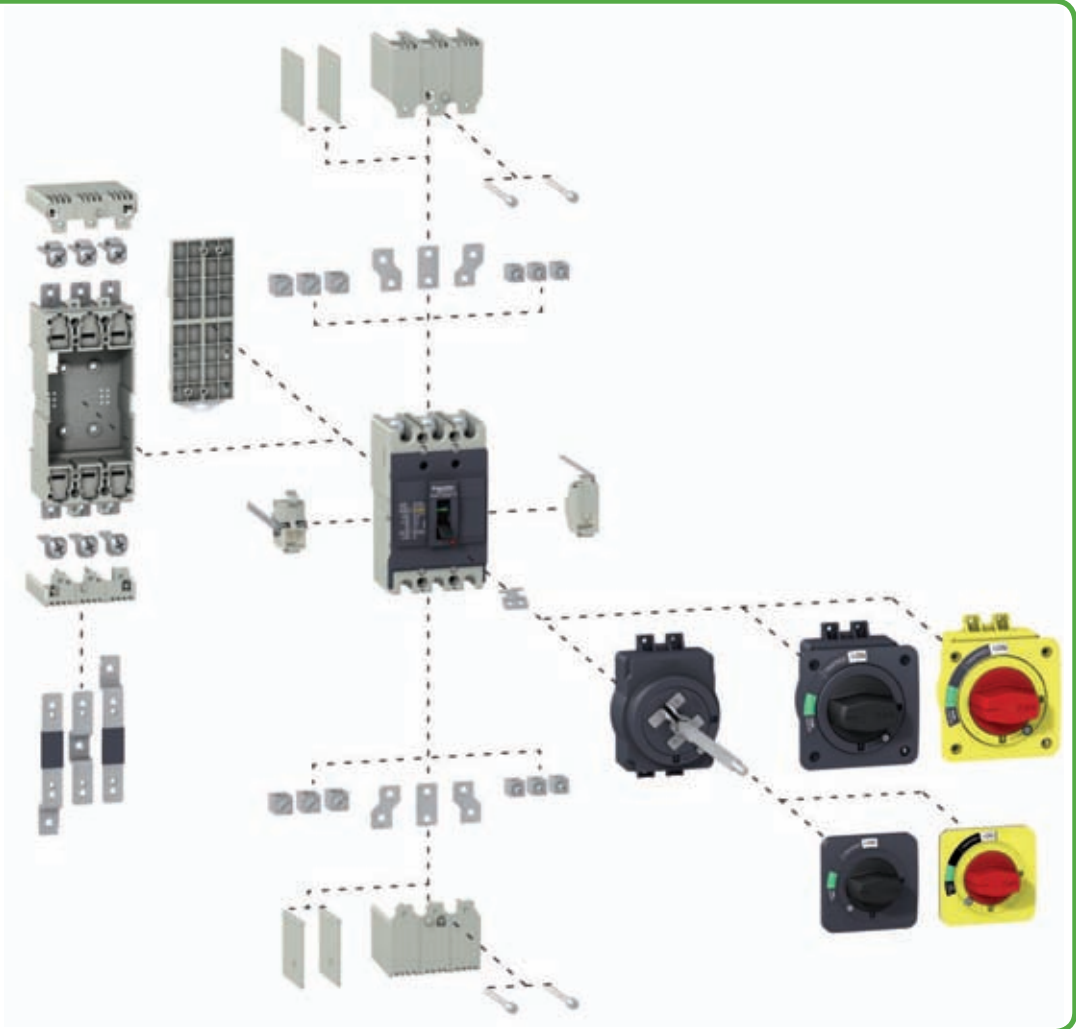

The **fishbone**, designed for vertical installation, saves space and reduces cabling time.

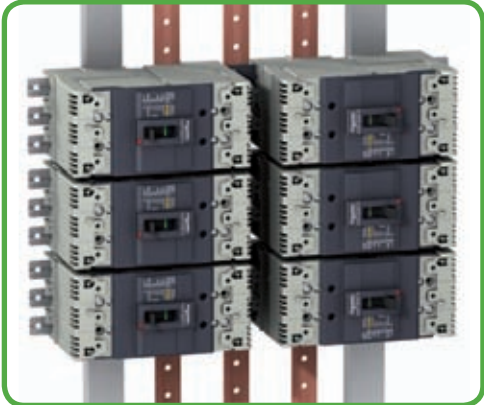

> Make the most of your energy™

<i>Presentation</i>	//
General characteristics	A-2
Selection table	A-6
Electrical and mechanical accessories overview	
EasyPact EZC100	A-10
EasyPact EZC250	A-11
EasyPact EZCV250	A-12
EasyPact EZC400	A-13
Electrical auxiliaries 100-250AF	
AX - AL - AXAL - ALV	A-14
SHT - UVR - UVRN	A-16
Direct rotary handle 100-250AF	A-18
Extended rotary handle 100-250AF	A-19
Plug-in	
100 A	A-20
Insulation of live parts	A-21
250 A	A-22
Insulation of live parts	A-23
Power connections and cable lugs 100-250AF	A-24
Power connections and insulation of live parts 100-250AF	A-25
DIN rail adaptor, padlocking, sealing screws 100-250AF	A-26
Electrical auxiliaries 400AF	
AX - AL	A-28
SHT - UVR	A-29
Direct rotary handle 400AF	A-30
Extended rotary handle 400AF	A-31
Power connections, cable lugs, spreaders and extensions 400AF	A-32
Insulation of live parts and padlocking 400AF	A-33
<i>Busbars</i>	<i>B-1</i>
<i>Installation guide</i>	<i>C-1</i>
<i>Catalogue numbers</i>	<i>D-1</i>

DB125804_Moc.eps

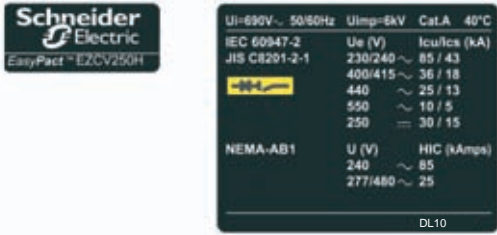

Compliance with standards

EasyPact circuit breakers and auxiliaries comply with the following international standards:

- IEC 60947-1 - general rules
- IEC 60947-2 - low-voltage switchgear and controlgear, part 2 (circuit breakers)
- European (EN 60947-1 and EN 60947-2) and the corresponding national standards
- GB 14048.2
- JIS C8201-2-1 Annex 1 and Annex 2, for molded case circuit breakers
- JIS C8201-2-2 Annex 1 and Annex 2, for earth-leakage circuit breakers
- NEMA-AB1 (High Interrupting Capacity): American standard
- UL508/CSA 22-2 no. 14.

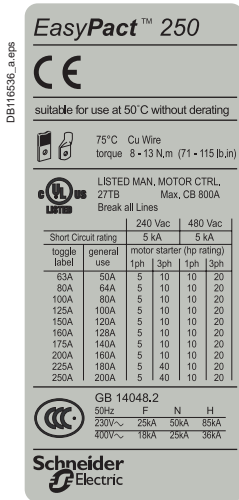

Example for 250 A frame.

Standardised characteristics indicated on the rating plate:

- Ui:** rated insulation voltage
- Uimp:** rated impulse withstand voltage
- Ue:** rated operational voltage
- Icu:** ultimate breaking capacity, for various values of the rated operational voltage Ue
- Cat:** utilisation category
- Ics:** service breaking capacity
- In:** rated current
- XI** suitability for isolation

Approvals and Certifications

- IEC certification by independent laboratories (ASEFA, KEMA, TÜV)
- CE marking
- CCC certified by third party Tilva
- UL LISTED certified by third party Underwriter Laboratories as a "Manual Motor Controller" (EZC250/EZCV250/EZC400).

Vibration and shock withstand test

EasyPact circuit breakers resist mechanical vibrations and shocks.

Tests are carried out in compliance with standard IEC 60068-2-6 for the levels required by merchant-marine inspection organisation IACS:

- International Association of Classification Societies up to 250 A (ABS, BV, DNV, GL, LR, KRS, RINA, NK):
- 2 to 13.2 Hz: amplitude ± 1 mm
- 13.2 to 100 Hz: acceleration 0.7 g.

Pollution degree

EasyPact circuit breakers are certified for operation in pollution-degree III environments as defined by IEC standard 60947 (industrial environments).

Tropicalisation

EasyPact circuit breakers have successfully passed the tests prescribed by the following standards for extreme atmospheric conditions:

- IEC 60068-2-1 - dry cold (-55 °C)
- IEC 60068-2-2 - dry heat (+85 °C)
- IEC 60068-2-30 - damp heat (95 % relative humidity at 55 °C)
- IEC 60068-2-52 - salt mist (severity level 2).

Positive contact indication

All EasyPact circuit breakers are suitable for isolation as defined in IEC standard 60947-2:

- the isolation position corresponds to the O (OFF) position
- the operating handle cannot indicate the O (OFF) position ("green colour" visible) unless the contacts are effectively open
- padlocks may not be installed unless the contacts are open
- installation of a rotary handle does not alter the reliability of the position-indication system.

The isolation function is certified by tests guaranteeing:

- the mechanical reliability of the position indication system
- the absence of leakage currents
- overvoltage withstand capacity between upstream and downstream connections.

EasyPact circuit breakers take into account important concerns for environmental protection. Most components are recyclable and the parts are marked as specified in applicable standards.

PB101844_SE_25.eps



DB119518.eps



Ambient temperature

- EasyPact circuit breakers has been particularly designed to hold 100 % In at 50 °C without tripping in normal condition (except for earth-leakage circuit breakers).
- EasyPact circuit breakers may be used between -25 °C and +70 °C.
- The permissible storage-temperature range for EasyPact circuit breakers in the original packing is -35 °C to +85 °C.

Installation

EasyPact circuit breakers are designed for easy installation in the various types of switchboards. They may be mounted vertically, horizontally or flat on their back without any derating of characteristics.

Power supply

EasyPact circuit breaker can be supplied from either the top or the bottom (reverse feeding) without any reduction in performance. For earth-leakage circuit breakers, reverse feeding is possible only up to 240 V AC. This capability facilitates connection when installed in a switchboard.

Degree of protection

As per standards IEC 60529 (IP degree of protection) and EN 50102 (IK degree of protection against external mechanical impacts).

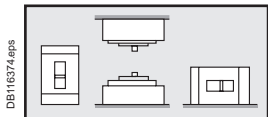

Installation positions.

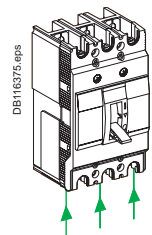

Reverse feeding.

Bare circuit breaker with terminal shields

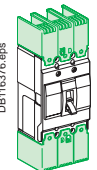
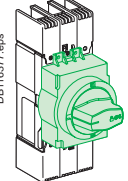
	With toggle	IP20	IK07
	With direct rotary handle standard	IP40	IK07

Circuit breaker installed in a switchboard

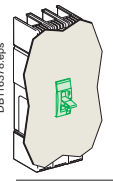
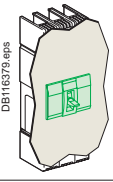
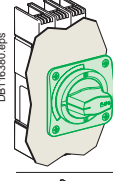
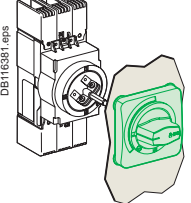
		With toggle	IP40	IK07
		With direct rotary handle standard/VDE MCC	IP54	IK07
		With extended rotary handle	IP54	IK08



PB101851_SE_37.eps

Earth-leakage protection

EasyPact circuit breakers have a specific version including earth-leakage protection. This protection is fully integrated inside the breaker and does not require any additional space.

EasyPact circuit breakers and earth-leakage circuit breakers are fully interchangeable.

Compliance with standards

EasyPact earth-leakage circuit breakers comply with all the international standards listed [page A-2](#):

- IEC 60947-1
- IEC 60947-2
- EN 60947-1
- EN 60947-2
- GB 14048.2
- JIS C8201-2-2 Annex 1 and Annex 2
- NEMA-AB1 (High Interrupting Capacity)
- UL508/CSA 22-2 no. 14.

They also comply with:

- VDE 664, operation down to -25 °C
- IEC 60255-4 and IEC 60801-2 to 60801-5 covering protection against nuisance tripping due to transient overvoltages, lightning strikes, switching of devices on the distribution system, electrostatic discharges, radiofrequency interference.

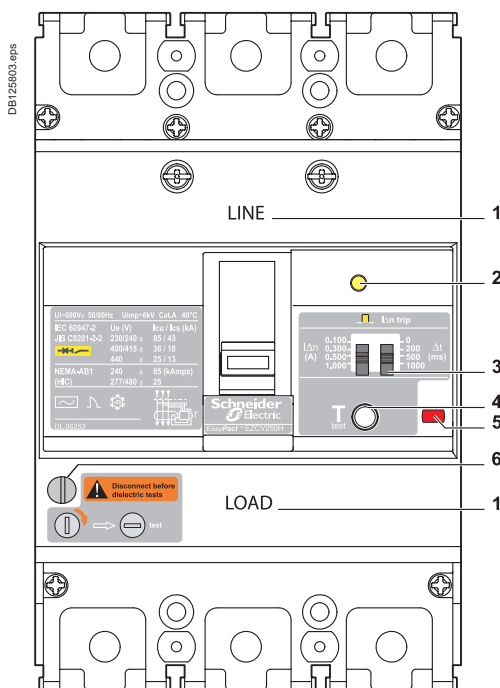

DB125803.eps

- 1 Line-Load ($U_e > 300$ V AC)
- 2 Mechanical indicator (ELCB)
- 3 Adjustable settings $I_{\Delta n}$ and time delay
- 4 ELCB test button
- 5 Push to trip button (MCCB)
- 6 Dielectric tests: disconnecting switch

Power supply

Reverse feeding

EasyPact earth-leakage circuit breakers can be supplied from either the top or the bottom for voltages up to 300 V AC. For voltages over 300 V AC, only supply from the top is possible (Line-Load indication on the cover of the breaker).

Power supply of the electronics

EasyPact earth-leakage circuit breakers are self-supplied by the distribution-system voltage and therefore do not require any external source. They fully comply with new IEC requirements (Annex B): they are powered from the three phases and continue to function even if one phase is missing.

Dielectric tests

EasyPact earth-leakage circuit breakers are equipped with a disconnecting switch in order to protect the electronics during dielectric tests.

When the disconnecting switch is activated, the circuit breaker is automatically tripped. It is mechanically impossible to switch on the circuit breaker, until the earth-leakage function is re-energised.

Tripping features

Tripping indications:

- EasyPact earth-leakage circuit breakers have a yellow mechanical indicator to locally signal tripping due to an earth fault.
- EasyPact earth-leakage circuit breakers may be equipped with an earth-leakage alarm switch (ALV) to remotely signal tripping due to an earth fault.

Resetting

EasyPact earth-leakage circuit breakers are fully reset by the operating handle. After resetting, tripping indicators (mechanical and ALV) come to normal position.

ELCB protection characteristics

Sensitivity $I_{\Delta n}$ (A)		adjustable	0.1 - 0.3 - 0.5 - 1
Time delay	Intentional delay (ms)	adjustable	0 - 200 - 500 - 1000
	Max. breaking time (s)		0.15 - 0.4 - 1 - 2
Rated voltage	AC 50/60 Hz (V)		100...440

Earth-leakage circuit breakers

With three built-in protections:

- overload
- short-circuit
- earth-leakage.

From 63 A to 250 A

With adjustable sensibility and time delay

Up to 36 kA at 415 V

In 3 poles and 4 poles

DB 1 25805 eps

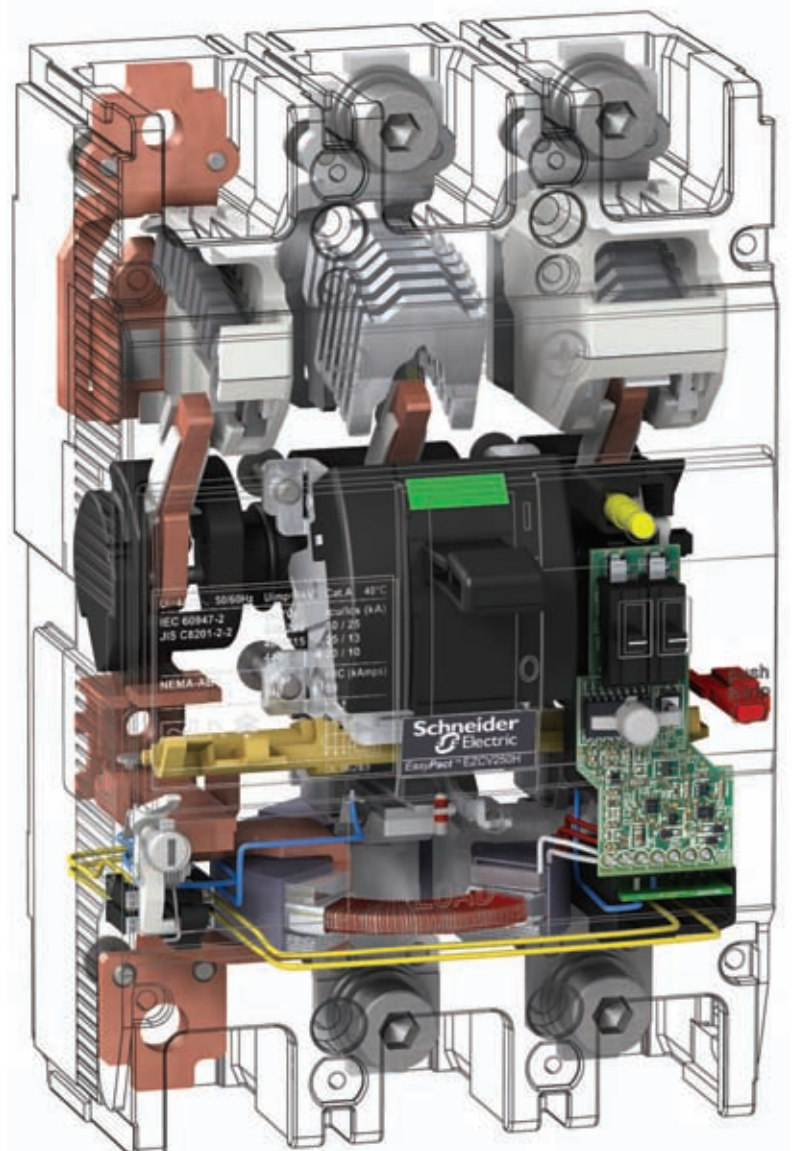



PB101838_SE_10.eps

EZC100-1P.



PB101840_SE_15.eps

EZC100-2P.



PB101843_SE_22.eps

EZC100-3P.



PB102172_SE_27.eps

EZC100-4P.



PB101846_SE_29.eps

EZC250-3P.

EasyPact circuit breakers

Fixed version		
Plug-in version		
Number of poles		
Rated current (A)	In	at 40 °C
Rated insulation voltage (V)		
Ui		
Rated impulse withstand voltage (kV)		
Uimp		
Rated operational voltage (V)		
Ue		AC 50/60 Hz DC

Electrical characteristics as per IEC 60947-2, EN 60947-2, JIS C8201-2-1

Ultimate breaking capacity (kA rms)	Icu	AC 50/60 Hz	110/130 V
			220/230/240 V
			380 V
			400/415 V
			440 V
DC	550 V		
	125 V (1P)		
	250 V (2P in series)		
Rated service breaking capacity (kA rms)	Ics	% Icu	110-400 V 415-550 V

Suitability for isolation		
Utilisation category		
Pollution degree		
Endurance (C-O cycles)	Mechanical	
	Electrical	In/415 V

Electrical characteristics as per NEMA-AB1

Breaking capacity (kA rms)	HIC	AC 50/60 Hz	240 V 277/480 V
----------------------------	------------	-------------	--------------------

Protection

Overload protection	Bimetal	
Instantaneous protection	Magnetic	Fixed (±20 %)

Auxiliaries

Indication contacts	Auxiliary switch	AX
	Alarm switch	AL
	Combined AX + AL	AXAL
Voltage releases	Shunt trip release	SHT
	Undervoltage release	UVR

Installation

Connection	Crimp lugs/bars	
Accessories	Box lugs for bare cables	
	Rotary handles	Direct Extended
	Terminal extensions	
	Spreaders	
	Phase barriers	
	Terminal shields	
	Padlocking system	
	DIN rail adaptor	

Dimension and weight

Dimensions (mm)	D x H	
	W	
Weight (kg)		

	EZC100B	EZC100F	EZC100N	EZC100H		EZC250F	EZC250N	EZC250H	
	■	■	■	■	■	■	■	■	
	■	■	-	■ ⁽⁴⁾	-	■	■	■	
	3	3	1	3-4	1	2-3-4	3	3	
	15, 16, 20, 25, 30, 32, 40, 45, 50, 60	15, 16, 20, 25, 30, 32, 40, 45, 50, 60, 63, 75, 80, 100	15, 16, 20, 25, 30, 32, 40, 45, 50, 60, 63, 75, 80, 100	15, 16, 20, 25, 30, 32, 40, 45, 50, 60, 63, 75, 80, 100	15, 16, 20, 25, 30, 32, 40, 45, 50, 60, 63, 75, 80, 100	15, 16, 20, 25, 30, 32, 40, 45, 50, 60, 63, 75, 80, 100	100, 125, 150, 160, 175, 200, 225, 250	100, 125, 150, 160, 175, 200, 225, 250	100, 125, 150, 160, 175, 200, 225, 250
	690	690	690	690	690	690	690	690	
	6	6	6	6	6	6	6	6	
	550	550	415	550	415	550	550	550	
	-	250	125	250	125	250	250	250	
	10	25	25	25	50	100	25	50	
	10	25	18	25	25	100 ⁽¹⁾	25	50	
	7.5	10	2.5	18	5	30	18	25	
	7.5	10	2.5	15	5	30	18	25	
	5	7.5	-	10	-	20	15	20	
	2.5	5	-	5	-	10	5	8	
	-	5	5	5	10	10	5	20	
	-	5	-	5	-	10	5	20	
	25 %	50 %	50 %	50 %	50 %	50 %	50 %	50 %	
	25 %	50 %	50 %	50 %	50 %	25 %	50 %	50 %	
	■	■	■	■	■	■	■	■	
	A	A	A	A	A	A	A	A	
	3	3	3	3	3	3	3	3	
	8 500	8 500	8 500	8 500	8 500	8 500	10 000	10 000	
	1 500	1 500	1 500	1 500	1 500	1 500	5 000	5 000	
	-	-	10	25	18	100	25	50	
	-	-	10 ⁽²⁾	10	18 ⁽²⁾	18 ⁽³⁾	15	18	
	fixed	fixed	fixed	fixed	fixed	fixed	fixed	fixed	
	fixed	fixed	fixed	fixed	fixed	fixed	10 ln	10 ln	
	■	■	-	■	-	■	■	■	
	■	■	-	■	-	■	■	■	
	■	■	-	■	-	■	■	■	
	■	■	-	■	-	■	■	■	
	■	■	-	■	-	■	■	■	
	■	■	■	■	■	■	■	■	
	■	■	■	■	■	■	■	■	
	■	■	-	■	-	■ ⁽³⁾	■	■	
	■	■	-	■	-	■ ⁽³⁾	■	■	
	-	-	-	-	-	-	■	■	
	■	■	-	■	-	■	■	■	
	■	■	■	■	■	■	■	■	
	■	■	-	■	-	■ ⁽³⁾	■	■	
	■	■	■	■	■	■	■	■	
	■	■	■	■	■	■	-	-	
	60 x 130	60 x 130	60 x 130	60 x 130	60 x 130	60 x 130	60 x 165	60 x 165	
	75	75	25	75 (3P) 100 (4P)	25	50 (2P) 75 (3P) 100 (4P)	105	105	
	0.78	0.78	0.28	0.78 (3P) 1.0 (4P)	0.28	0.6 (2P) 0.78 (3P) 1.0 (4P)	1.3	1.3	
							1.1 (2P) 1.3 (3P)		

(1) 50 kA for 2 poles.
(2) For 277 V only.
(3) For 3 and 4 poles only.
(4) For 3P only.



PB101852_SE_32.eps

EVC250.



PB101854_SE_34.eps

EVC250-4P.



PB102114_SE_28.eps

EVC400-3P.



PB102115_SE_36.eps

EVC400-4P.

EasyPact circuit breakers

Fixed version		
Plug-in version		
Number of poles		
Rated current (A)	In	at 40 °C
Rated insulation voltage (V)	Ui	
Rated impulse withstand voltage (kV)	Uimp	
Rated operational voltage (V)	Ue	AC 50/60 Hz DC

Electrical characteristics as per IEC 60947-2, EN 60947-2 and JIS C8201-2-1/C8201-2-2

Ultimate breaking capacity (kA rms)	Icu	AC 50/60 Hz	220/230/240 V 380 V 400/415 V 440 V 550 V
		DC	125 V (1P) 250 V (2P in series)

Rated service breaking capacity (kA rms)	Ics	% Icu
Suitability for isolation		
Utilisation category		
Pollution degree		
Endurance (C-O cycles)	Mechanical	
	Electrical	In/415 V

Electrical characteristics as per NEMA-AB1

Breaking capacity (kA rms)	HIC	AC 50/60 Hz	240 V 277/480 V
----------------------------	------------	-------------	--------------------

Protection

Overload protection	Bimetal	
Instantaneous protection	Magnetic	fixed ($\pm 20\%$)

Earth-leakage protection

Sensitivity (A)	$I\Delta n$	adjustable
Time-delay (ms)	Δt	adjustable
Max. breaking time (s)	at $2 I\Delta n$	

Auxiliaries

Indication contacts	Auxiliary switch	AX
	Alarm switch	AL
	Combined AX + AL	AXAL
	Earth-alarm switch	ALV
Voltage releases	Shunt trip release	SHT
	Undervoltage release	UVR

Installation

Connection	Crimp lugs / bars	
Accessories	Box lugs for bare cables	
	Rotary handles	Direct Extended
	Terminal extensions	
	Spreaders	
	Phase barriers	
	Terminal shields	
	Padlocking system	

Dimension and weight

Dimensions (mm)	D x H W
-----------------	------------

Weight (kg)	
-------------	--

	EZC250N	EZC250H	EZCV250N	EZCV250H	EZC400N	EZC400H
■	■	■	■	■	■	■
■	■	■	■	■	-	-
4	4	4	3-4	3-4	3-4	3-4
63, 80, 100, 125, 150, 160, 175, 200, 225, 250	63, 80, 100, 125, 150, 160, 175, 200, 225, 250	63, 80, 100, 125, 150, 160, 175, 200, 225, 250	63, 80, 100, 125, 150, 160, 175, 200, 225, 250	63, 80, 100, 125, 150, 160, 175, 200, 225, 250	250, 300, 320, 350, 400	250, 300, 320, 350, 400
690	690	690	440	440	690	690
6	6	6	6	6	8	8
550	550	550	440	440	550	550
250	250	250	-	-	250	250
50	85	85	85	100	85	100
25	36	36	25	36	36	50
25	36	36	25	36	36	50
20	25	25	20	25	36	50
8	10	10	-	-	15	20
20	30	30	-	-	-	-
20	30	30	-	-	20	40
50 %	50 %	50 %	50 %	50 %	50 %	50 %
■	■	■	■	■	■	■
A	A	A	A	A	A	A
3	3	3	3	3	3	3
10 000	10 000	10 000	10 000	10 000	4 000	4 000
5 000	5 000	5 000	5 000	5 000	1 000	1 000
50	85	85	50	85	50	85
18	25	25	-	-	25	35
fixed	fixed	fixed	fixed	fixed	fixed	fixed
10 ln	10 ln	10 ln	10 ln	10 ln	10 ln	10 ln
-	-	0.1/0.3/0.5/1	0.1/0.3/0.5/1	-	-	
-	-	0/200/500/1000	0/200/500/1000	-	-	
-	-	0.15/0.4/1/2	0.15/0.4/1/2	-	-	
■	■	■	■	■	■	
■	■	■	■	■	■	
■	■	■	■	■	■	
-	-	■	■	-	-	
■	■	■	■	■	■	
■	■	■	■	■	■	
■	■	■	■	■	■	
■	■	■	■	■	■	
■	■	■	■	■	■	
■	■	■	■	■	■	
■	■	■	■	■	■	
■	■	■	■	■	■	
■	■	■	■	■	■	
■	■	■	■	■	■	
■	■	■	■	■	■	
■	■	■	■	■	■	
68 x 165	68 x 165	68 x 165	68 x 165	103 x 257	103 x 257	
140	140	105 (3P) 140 (4P)	105 (3P) 140 (4P)	140 (3P) 185 (4P)	140 (3P) 185 (4P)	
1.8	1.8	1.6 (3P) 2.1 (4P)	1.6 (3P) 2.1 (4P)	5 (3P) 7.5 (4P)	5 (3P) 7.5 (4P)	

Electrical and mechanical accessories overview

EasyPact EZC100

EasyPact circuit breaker EZC100 comes with a full range of accessories to fulfill different application requirements and make it easy for the end-user.

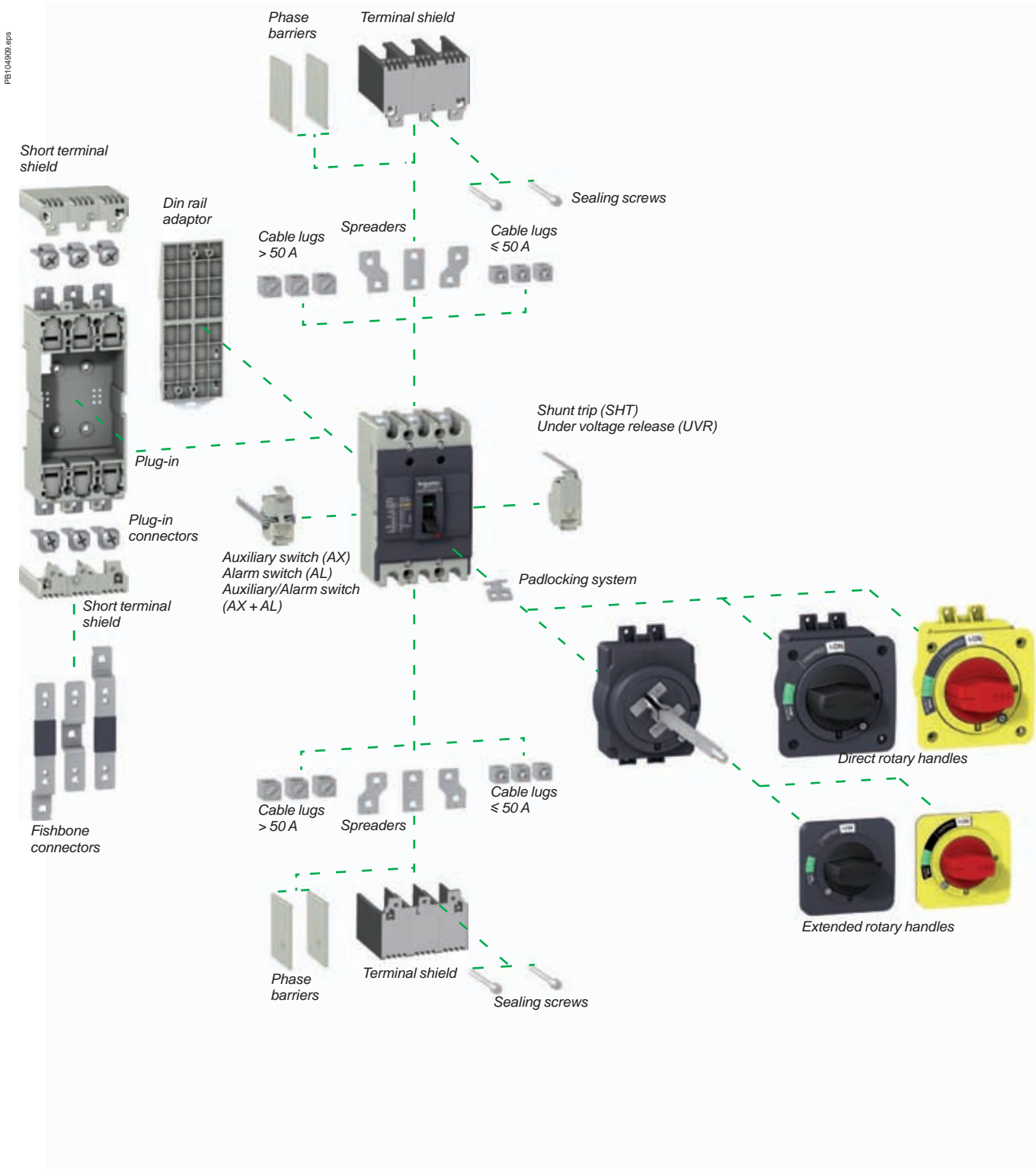

EasyPact EZC250

EasyPact circuit breaker EZC250 comes with a full range of accessories to fulfill different application requirements and make it easy for the end-user.

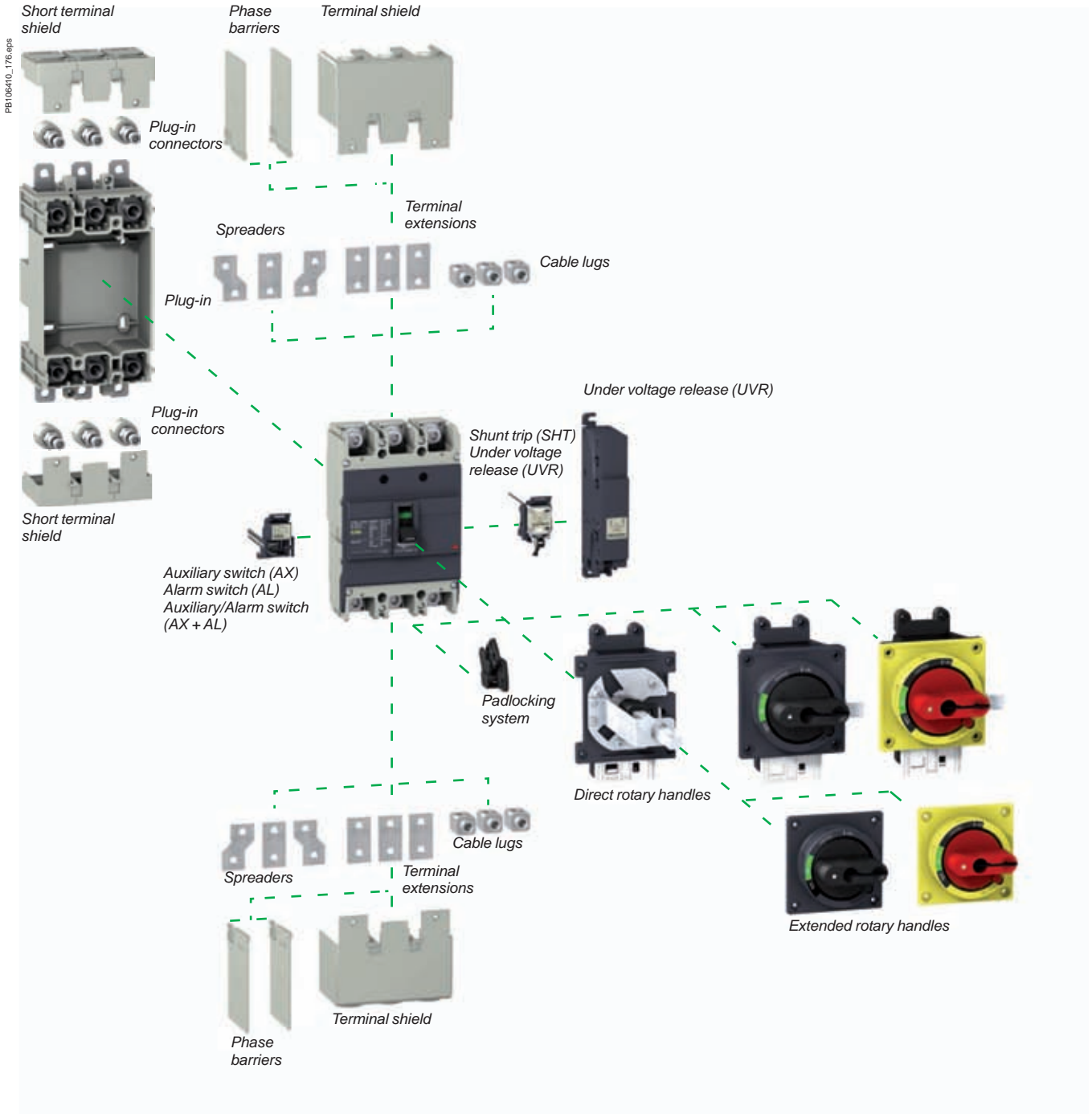

Electrical and mechanical accessories overview

EasyPact EZCV250

EasyPact circuit breaker EZCV250 comes with a full range of accessories to fulfill different application requirements and make it easy for the end-user.

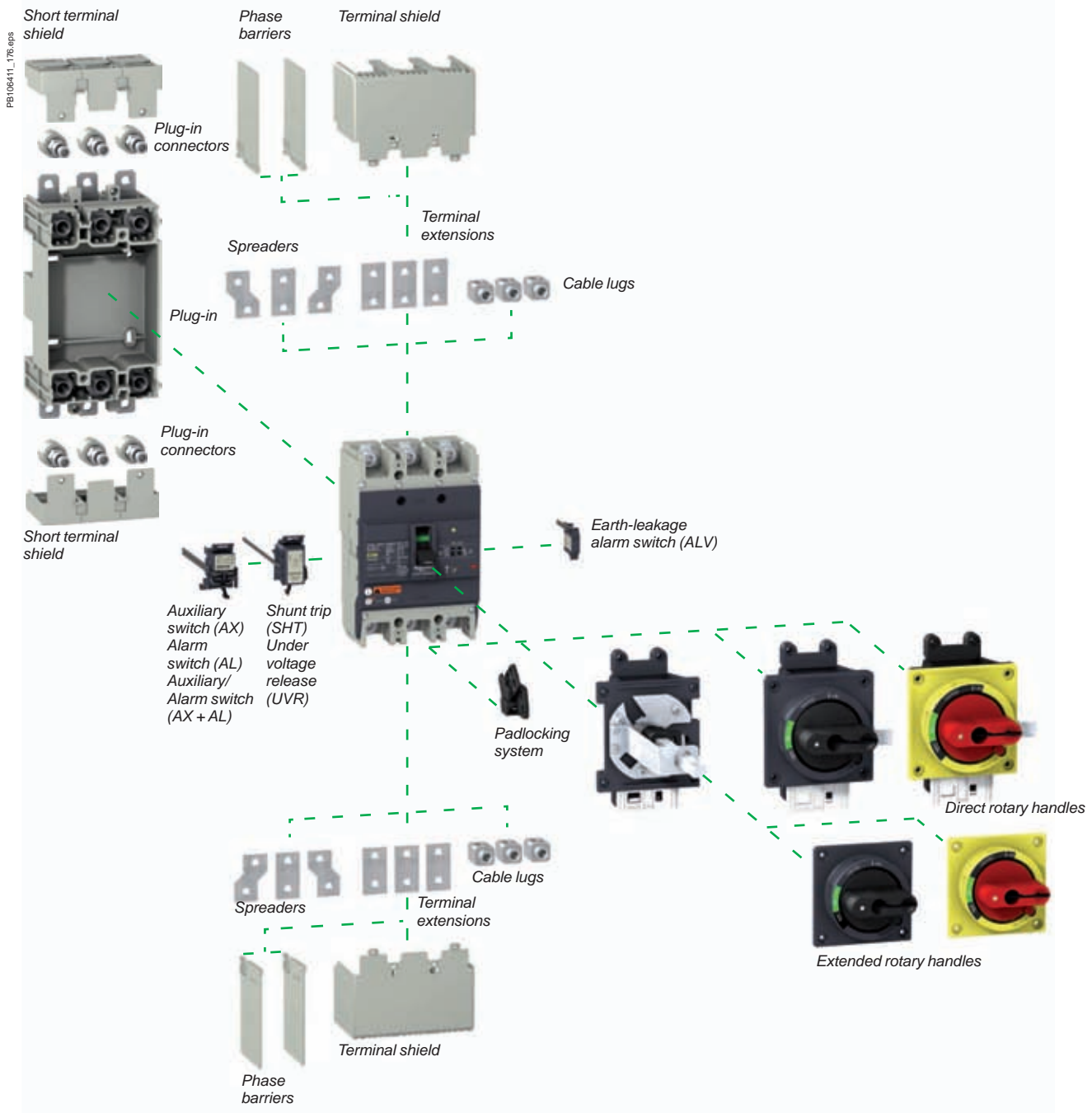

EasyPact EZC400

EasyPact circuit breaker EZC400 comes with a full range of accessories to fulfill different application requirements and make it easy for the end-user.

PE104753.eps

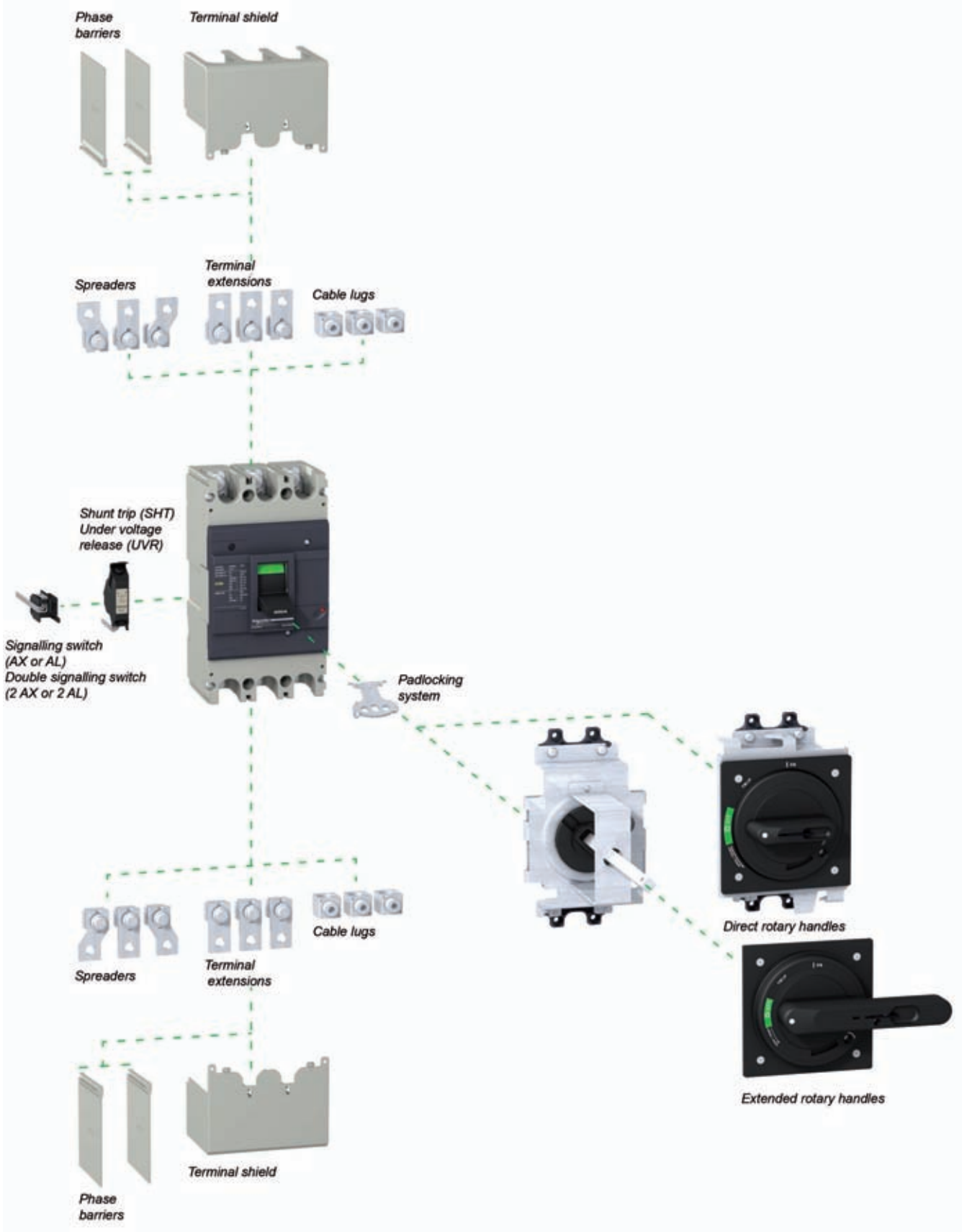

Electrical auxiliaries 100-250AF AX - AL - AXAL - ALV



PB101895-32.eps

EZC100.



PB102164-35.eps

AXAL and AX electrical auxiliaries on EZC100.



PB102166-35.eps

AXAL electrical auxiliaries on EZC250.



PB102169-42.eps

AXAL, AX and ALV electrical auxiliaries on EZCV250.

Plug-in location: AX - AL - AXAL - ALV

EZC100

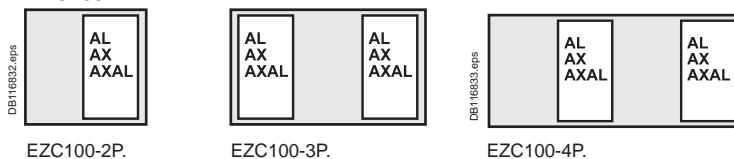

EZC250

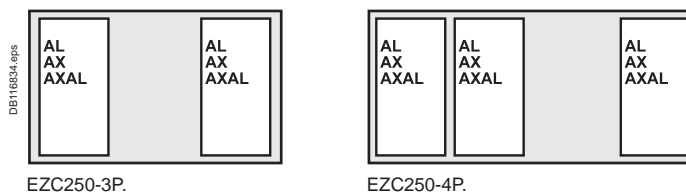

EZCV250

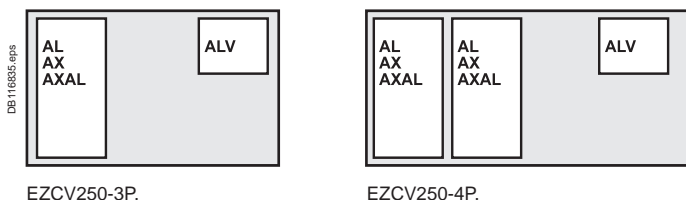

Indication contacts

Provide remote circuit breaker status information. They can be used for indications, electrical locking, relaying, etc. Common-point changeover contacts.

Auxiliary switch (ON/OFF)

AX indicates the position of the circuit breaker contacts.

Alarm switch (trip indication)

- AL indicates that the circuit breaker has tripped due to:
 - an overload
 - a short-circuit
 - operation of a voltage release.
- ALV indicates that the circuit breaker has tripped due to an of earth-leakage fault.

They return to de-energised state when the circuit breaker is reset.

Characteristics

Contacts				
Rated thermal current (A)	5			
Minimum load	10 mA at 24 V			
Utilisation category (IEC 60947-5-1)	AC12	AC15	DC12	DC14
Operational current (A)	24 V	5	4	3
	48 V	5	2.5	1
	125 V	5	0.4	0.4
	250 V	3	0.2	0.2
Connections				
Connection wire length	450 mm			
Cross-section	EZC100: 1 mm ² ,			
	EZC250/EZCV250: 1.5 mm ²			

PB101862-21.eps



Auxiliary switch (AX)
EZAUX10.

PB101876-21.eps



Auxiliary switch (AX)
EZEAX.

PB101883-28.eps



Earth-leakage alarm switch
(ALV).

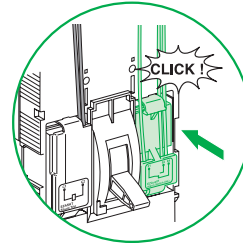
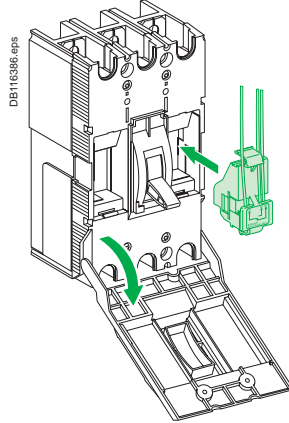

All EasyPact electrical
auxiliaires are
"snapped in place"

Designation	Cat. no.	
Auxiliary switch (AX)	EZAUX10	EZEAX
Alarm switch (AL)	EZAUX01	EZEAL
Auxiliary/Alarm switch (AXAL)	EZAUX11	EZEAXAL
Earth-leakage alarm switch (ALV)	-	EZEALV ⁽¹⁾

(1) Only EZCV250.

Electrical auxiliaries

100-250AF

SHT - UVR - UVRN



EZC250.



SHT and UVR releases on EZC100.



SHT and UVR releases on EZC250.



UVRN release on EZC250.

Plug-in location : SHT - UVR - UVRN

EZC100

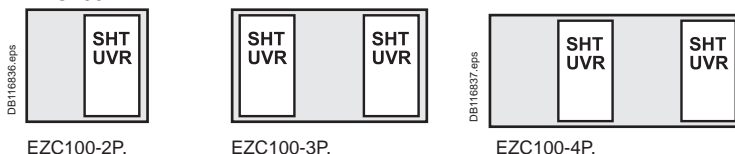

EZC250

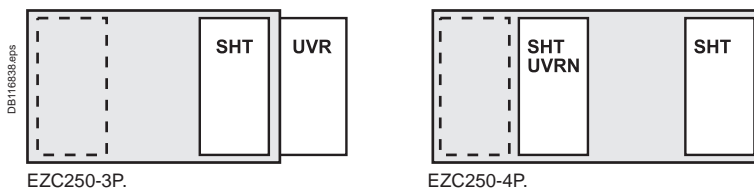

EZCV250

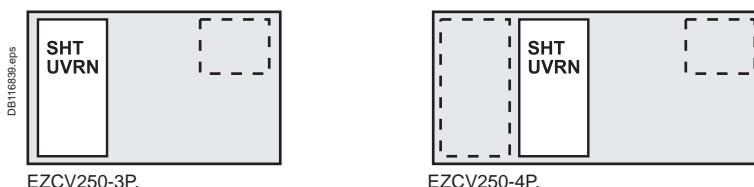

Remote tripping

Shunt Trip (SHT) or Under Voltage Release (UVR/UVRN).

Shunt Trip (SHT)

- This release trips the circuit breaker when the control voltage rises above $0.7 \times U_n$
- Control signals can be of the impulse type (≥ 20 ms) or maintained.

Under Voltage Release (UVR/UVRN)

- This release trips the circuit breaker when the control voltage drops below a tripping threshold
- Tripping threshold between 0.35 and 0.7 times the rated voltage
- Circuit breaker closing is possible only if the voltage exceeds 0.85 times the rated voltage.

Operation

When the circuit breaker has been tripped by an SHT or UVR/UVRN release, it must be reset locally:

- SHT or UVR/UVRN tripping takes priority over manual closing
- in the presence of a standing trip order, closing of the contacts, even temporary, is not possible.

Circuit breaker tripping by an SHT/UVR/UVRN release meets the requirements of standard IEC 60947-2.

Characteristics

Mechanical				
Mechanical endurance	10 % of MCCB mechanical endurance			
Electrical		EZC100	EZC250/EZCV250	
		AC/DC	AC	DC
SHT	pick-up consumption	< 30 VA	< 30 VA	< 35 W
	response time	< 50 ms	< 50 ms	< 100 ms
UVR	seal-in consumption	< 5 VA	< 5 VA	< 10 W
	response time	< 50 ms	< 50 ms	< 100 ms
UVRN	seal-in consumption	< 5 VA	< 5 VA	< 10 W
	response time	< 50 ms	< 50 ms	< 100 ms
Connections		EZC100	EZC250/EZCV250	
SHT		pre-wired (1 mm ²)	pre-wired (0.5 mm ²)	
UVR		pre-wired (1 mm ²)	screws (< 2 mm ²)	
UVRN		pre-wired (1 mm ²)	pre-wired (0.5 mm ²)	

PB101885-16.eps



Shunt Trip EZASHT.

PB101879-18.eps



Shunt Trip EZESHT.

PB101886-18.eps

Under Voltage Release
EZAUVR.

PB101894-27.eps

Under Voltage Release
EZEUVRN.

PB101880-15.eps

Under Voltage Release
EZEUVR.

Installation

- EYC100 SHT and UVR: internal mounting
- EYC250/EYCV250:
 - SHT: internal mounting
 - UVR: external mounting
 - UVRN: internal mounting

Designation		Cat. no.			
		EYC100		EYC250/EYCV250	
SHT	AC	100-130 V	EZASHT100AC	110-120 V	EZESHT100AC
		200-277 V	EZASHT200AC	120-130 V	EZESHT120AC
				200-240 V	EZESHT200AC
				277 V	EZESHT277AC
380-480 V	EZASHT380AC	380-440 V	EZESHT400AC		
DC	24 V	EZASHT024DC	380-440 V	EZESHT440AC	
	48 V	EZASHT048DC	440-480 V	EZESHT440AC	
UVRN	AC	110-130 V	-	110-120 V	EZESHT100AC
		200-240 V	-	120-130 V	EZESHT120AC
		277 V	-	200-240 V	EZESHT200AC
		380-415 V	-	277 V	EZESHT277AC
		440-480 V	-	380-440 V	EZESHT400AC
DC	24 V	-	380-440 V	EZESHT400AC	
	48 V	-	440-480 V	EZESHT440AC	
	125 V	-			
UVR	AC	110-130 V	EZAUVR110AC	110-120 V	EZESHT100AC
		200-240 V	EZAUVR200AC	120-130 V	EZESHT120AC
		277 V	EZAUVR277AC	200-240 V	EZESHT200AC
		380-415 V	EZAUVR380AC	277 V	EZESHT277AC
	440-480 V	EZAUVR440AC	380-440 V	EZESHT400AC	
	DC	24 V	EZAUVR024DC	380-440 V	EZESHT400AC
48 V		EZAUVR048DC	440-480 V	EZESHT440AC	
	125 V	EZAUVR125DC			

Direct rotary handle 100-250AF



PB101867-31.eps

Direct rotary handle (black) for EZC100.



PB102155-30.eps

Direct rotary handle (red/yellow) for EZC100.



PB107851-33.eps

Direct rotary handle (black) for EZC250/EZCV250.



PB102157-33.eps

Direct rotary handle (red/yellow) for EZC250/EZCV250.

Direct rotary handle

Suitable for Motor Control Centre (MCC) switchboards.

- Degree of protection IP40 or IP54, IK07 (IP54 with gasket supplied).
- The direct rotary handle maintains:
 - suitability for isolation
 - indication of the three positions O (OFF), I (ON) and tripped
 - circuit breaker locking capability in the OFF position by one to three padlocks, (padlock not supplied) shackle diameter Ø 5 for EZC100, Ø 8 for EZC250/EZCV250
 - door opening disabled when the circuit breaker is ON
 - circuit breaker closing is disabled if the door is open.

IP40 or IP54

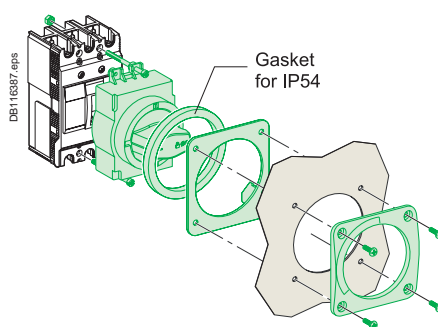

EZC100.

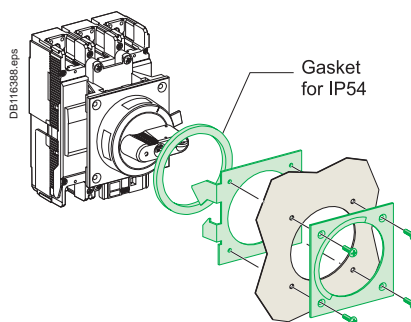

EZC250/EZCV250.

Padlocking

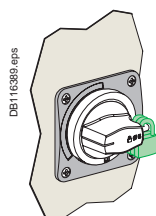

EZC100.

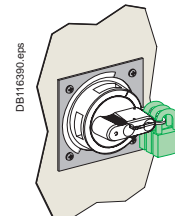

EZC250/EZCV250.

Designation

Designation	Cat. no.	
Direct rotary handle (black)	EZAROTDS	EZEROTDS
Direct rotary handle (red/yellow)	EZAROTDSRY	EZEROTDSRY

Extended rotary handle 100-250AF



Extended rotary handle (black) for EZC100.



Extended rotary handle (red/yellow) for EZC100.



Extended rotary handle (black) for EZC250/EZCV250.

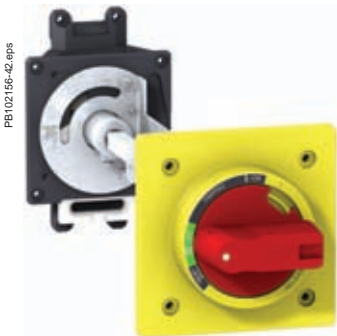

Extended rotary handle (red/yellow) for EZC250/EZCV250.

Extended rotary handle

The extended rotary handle is used to control, from the front face of the switchboard, a device installed at the back of the switchboard.

- Degree of protection IP40 or IP54, IK08 (IP54 with gasket supplied).
- The extended rotary handle maintains:
 - suitability for isolation
 - indication of the three positions O (OFF), I (ON) and tripped
 - circuit breaker locking capability in the OFF position by one to three padlocks, (padlock not supplied) shackle diameter: Ø 5 for EZC100, Ø 8 for EZC250/EZCV250
 - door opening disabled when the circuit breaker is ON.
- The extended rotary handle is made up of:
 - a unit on the front cover of the circuit breaker (secured by screws)
 - an assembly (handle and front plate) on the door that is always secured in the same position, whether the circuit breaker is installed vertically or horizontally
 - an extension shaft that must be adjusted to the distance between back of circuit breaker and door.

IP40 or IP54

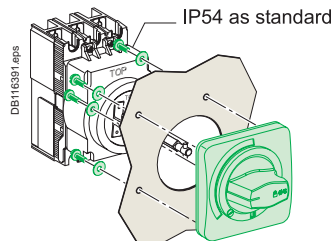

EZC100.

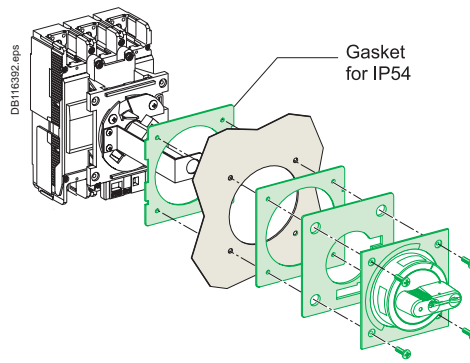

EZC250/EZCV250.

Padlocking

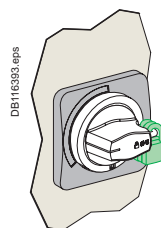

EZC100.

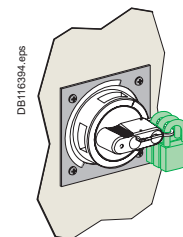

EZC250/EZCV250.

Designation

Cat. no.

Designation	Cat. no.	
Extended rotary handle (black)	EZC100	EZC250/EZCV250
	EZAROTE	EZEROTE
Extended rotary handle (red/yellow)	EZAROTERY	EZEROTERY

The plug-in allows you to connect, disconnect from the circuit breaker rapidly.



Plug-in

The plug-in base is equipped with terminals which, depending on their orientation, serve for front and rear connection. Degree of protection IP20.

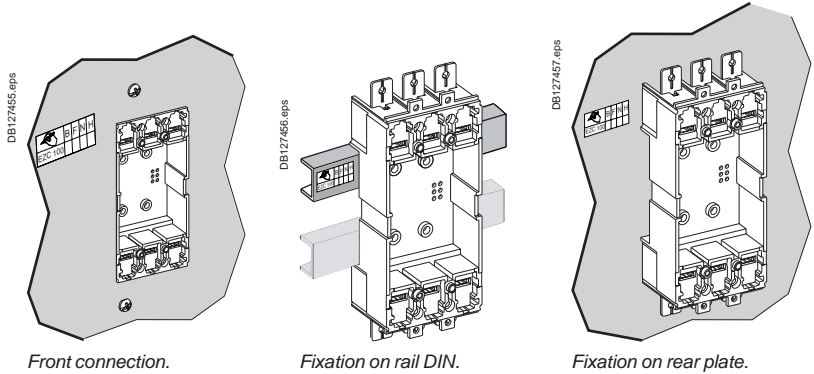

Connection accessories

All accessories for fixed devices (bars, lugs) may be used with the plug-in base.

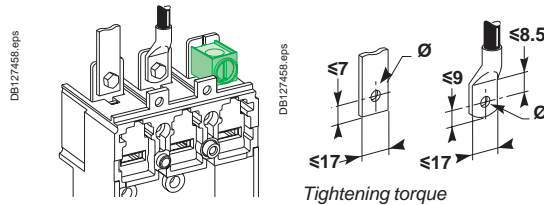

EZAPCON1L



EZAPCON1H



EZAFSHB3

References Plug-in

100 A

EZAPLUG3L	Kit, plug-in base 3P 15 A-50 A
EZAPLUG3H	Kit, plug-in base 3P 60 A-100 A
EZAFSHB3 - set of 3	Fishbone connectors
EZAPCON1L - set of 2	Plug-in connectors 15 A-50 A
EZAPCON1H	Plug-in connectors 60 A-100 A



Fishbone.

Fishbone

The fishbone, designed for vertical installation, saves space and reduces cabling time.

Insulation of live parts

Short terminal shield only.

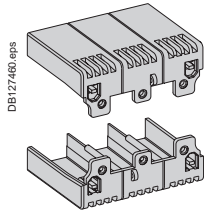

Terminal shields

Insulating accessories used for protection against direct contact with power circuits. They provide IP40 degree of protection and IK07 mechanical impact protection.

Terminal-shield types

Easycompact 100 to 250:

- short terminal shields

Short terminal shields

They are used with:

- plug-in in all connection configurations
- fixed versions with rear connection.

Terminal shields and pitch

Combination possibilities are shown below.

Circuit breaker Easycompact	100/160/250
Pitch (mm)	35

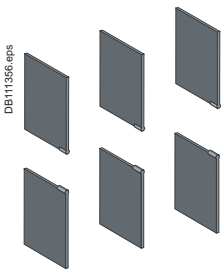

Interphase barriers

Safety accessories for maximum insulation at the power-connection points:

- they clip easily onto the circuit breaker
- single version for fixed devices and adapters on plug-in bases
- not compatible with terminal shields
- the adapter for the plug-in base is required for mounting on plug-in and withdrawable versions.

The plug-in allows you to connect, disconnect from the circuit breaker rapidly.

Plug-in

The plug-in base is equipped with terminals which, depending on their orientation, serve for front and rear connection. Degree of protection IP20.



PB106405-34.eps

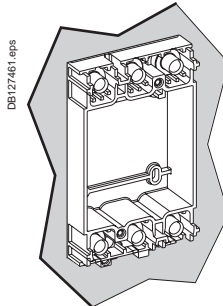

DB127461.eps

Front connection.

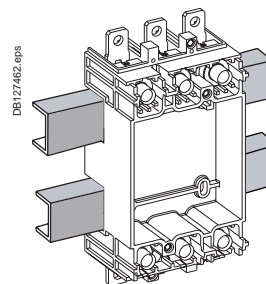

DB127462.eps

Fixation on rail DIN.

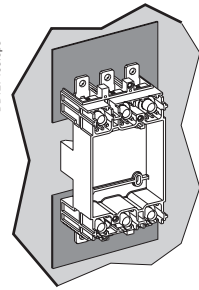

DB127463.eps

Fixation on rear plate.

Connection accessories

All accessories for fixed devices (bars, lugs).

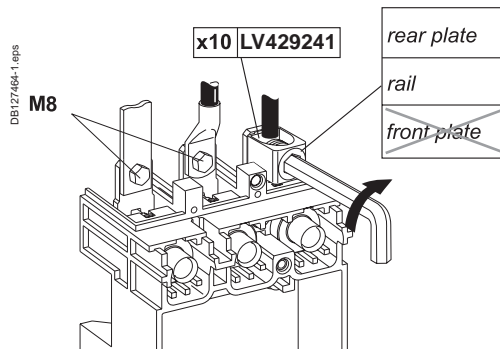

DB127464-1.eps

x10 LV429241

rear plate

rail

front plate

M8

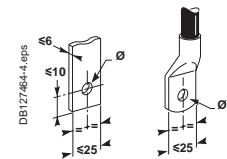

DB127464-4.eps

Tightening torque



PB106402-43.eps

EZEPCON1

References Plug-in	250 A
EZEPLUG3L - 60 mm breaker	Kit, plug-in base 3P 100 A - 250 A
EZEPLUG3H - 68 mm breaker	Kit, plug-in base 3P 100 A - 250 A
EZEPLUG4 - 68 mm breaker	Kit, plug-in base 4P 100 A - 250 A
EZEPCON1 - set of 2	Kit, plug-in connectors 100 A - 250 A

Insulation of live parts

Short terminal shield only



PB106406-45.eps

Terminal shields

Insulating accessories used for protection against direct contact with power circuits. They provide IP40 degree of protection and IK07 mechanical impact protection.

Terminal-shield types

Easypact 100 to 250:

- short terminal shields.

Short terminal shields

They are used with:

- plug-in in all connection configurations
- fixed versions with rear connection.

Terminal shields and pitch

Combination possibilities are shown below.

Circuit breaker Easypact	100/160/250
Short terminal shields	
Pitch (mm)	35

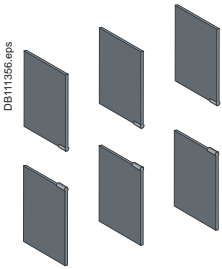

DB11356.eps

Interphase barriers.

Interphase barriers

Safety accessories for maximum insulation at the power-connection points:

- they clip easily onto the circuit breaker
- single version for fixed devices and adapters on plug-in bases
- not compatible with terminal shields
- the adapter for the plug-in base is required for mounting on plug-in and withdrawable versions.

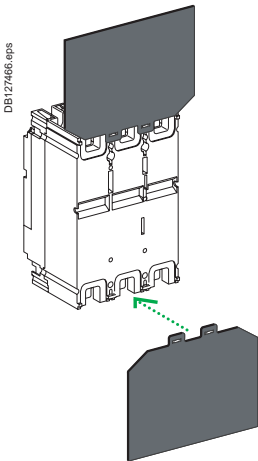

DB127466.eps

Rear insulating screens.

Rear insulating screens

Safety accessories providing insulation at the rear of the device.

Their use is mandatory for devices with spreaders, installed on backplates, when terminal shields are not used.

The available screen dimensions are shown below.

Circuit breaker Easypact	100/160/250	
3P	W x H x thickness (mm)	140 x 105 x 1
4P	W x H x thickness (mm)	175 x 105 x 1

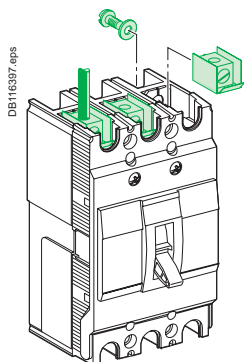
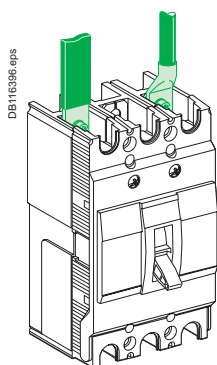
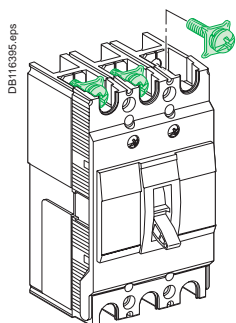

Standard circuit breaker terminals

All EasyPact circuit breakers are supplied with terminal screws

EZC100 15 to 50 A

Screw M5

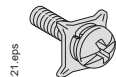

EZC100 60 to 100 A

Screw M8

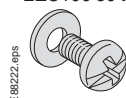

EZC250/EZCV250 63 to 250 A

Screw M8

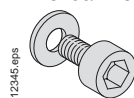

Connection of insulated bars or cables with lugs

Bars

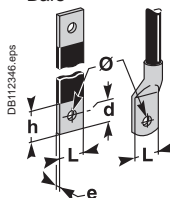

	EZC100	EZC250/ EZCV250
L (mm)	≤ 17	≤ 25
h (mm)	d + 10	d + 10
d (mm)	≤ 7	≤ 8
e (mm)	≤ 6	≤ 6
Ø (mm)	≤ 50 A	5.5
	> 50 A	8.5
		9

Crimp lugs

	EZC100	EZC250/ EZCV250
L (mm)	≤ 17	≤ 25
d (mm)	≤ 9	≤ 8
Ø (mm)	≤ 50 A	5.5
	> 50 A	8.5
		9

Tightening torque

≤ 50 A	2 N.m	-
> 50 A	5.5 N.m	13 N.m

Cable lugs

Cable lugs directly screwed on standard circuit breaker terminals.

≤ 50 A (EZC100)

> 50 A (EZC100)

≥ 100 A (EZC250/EZCV250)

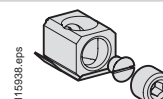
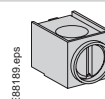
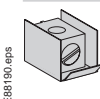

Cables from 2.5 to 16 mm².

Cables from 10 to 50 mm².

Cables from 42.2 to 150 mm².

Designation	Cat. no.	
	EZC100	EZC250/EZCV250
Cable lug up to 50 A (set of 2)	EZALUG0502 ⁽¹⁾	-
Cable lug up to 50 A (set of 3)	EZALUG0503 ⁽¹⁾	-
Cable lug from 60 A up to 100 A (set of 2)	EZALUG1002 ⁽²⁾	-
Cable lug from 60 A up to 100 A (set of 3)	EZALUG1003 ⁽²⁾	-
Cable lug from 100 A up to 250 A (set of 3)	-	EZELUG2503
Cable lug from 100 A up to 250 A (set of 4)	-	EZELUG2504

Important:

- (1) EZALUG0502 and EZALUG0503 can be use with maximum rating of 50 A.
- (2) EZALUG1002 and EZALUG1003 can be use with maximum rating of 100 A.

Power connections and insulation of live parts 100-250AF



Spreader.



Terminal extensions.



Phase barriers for Ezc100.



Phase barriers for Ezc250/
EzcV250.

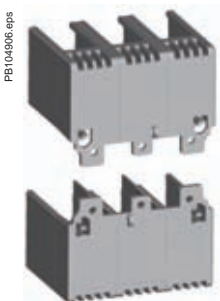

Terminal shield for Ezc100.

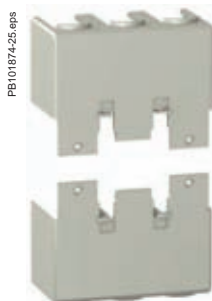

Terminal shield
for Ezc250/EzcV250.

Spreaders

Increase the pitch of the circuit breaker terminals:

- Ezc100 from 25 mm to 35 mm
- Ezc250/EzcV250 from 35 mm to 45 mm.

Terminal extensions

Additional terminal extensions are available for Ezc250/EzcV250 at 35 mm pitch.

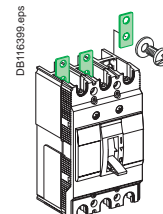
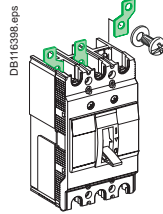

Designation	Cat. no.	
	Ezc100	Ezc250/EzcV250
Spreaders for 3-pole breaker (set of 3)	EZASPDR3P	EZESPDR3P
Spreaders for 4-pole breaker (set of 4)	EZASPDR4P	EZESPDR4P
Terminal extension for 3-pole breaker (set of 3)	-	EZETEX
Terminal extension for 4-pole breaker (set of 4)	-	EZETEX4P

Phase barriers

- Safety accessories for maximum insulation at the power connection points.
- Usable with all other connection accessories, except terminal shields.
- Each breaker is delivered with a set of phase barriers (1 for 2 poles, 2 for 3 poles and 3 for 4 poles breaker).
- Additional set of phase barriers available for insulation between outgoing or between 2 side by side mounted breakers.

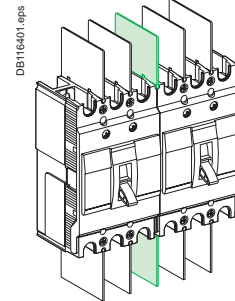
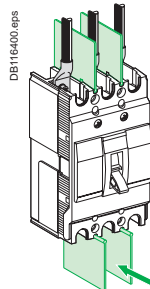

Designation	Cat. no.	
	Ezc100	Ezc250/EzcV250
Phase barriers for 60 mm depth (set of 2)	EZAFASB2	EZEFASB2
Phase barriers for 68 mm depth (set of 3)	-	EZEFASB3N

Terminal shields

- Insulating accessory used for protection against direct contacts with power circuit connections. It provides a degree of protection of IP20 and a mechanical resistance of IK07.
- The long terminal shield is used with front cable or isolated busbar connections.
- Designed for 3-pole Ezc100, 3, 4-pole Ezc250/EzcV250.

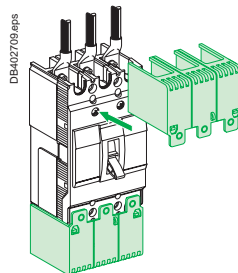

Designation	Cat. no.	
	Ezc100	Ezc250/EzcV250
Terminal shield 3P, 60 mm depth (set of 2)	EZATSHD3P	EZETSHD3P
Terminal shield 3P, 68 mm depth (set of 2)	-	EZETSHD3PN
Terminal shield 4P, 60 mm depth (set of 2)	EZATSHD4P	-
Terminal shield 4P, 68 mm depth (set of 2)	-	EZETSHD4PN

DIN rail adaptor, padlocking, sealing screws 100-250AF



Padlocking device for
EVC100.



Padlocking device for
EVC250/EVCV250.

DIN rail adaptor

Breaker mounting on a DIN rail is possible by using special adaptor (EVC100 only).

Number of adaptators:

- one for two 1P, or one 2P or one 3P
- two for one 4P.

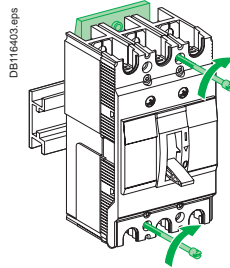

Mounting on DIN rail (optional).

Designation	Cat. no.	
	EVC100	EVC250/EVCV250
Din rail adaptor	EZADINR	-

Padlocking system

Locking in the OFF position guarantees isolation as per IEC 60947-2.

Padlocking system can receive:

- up to 2 padlocks Ø 5 mm (padlocks not supplied) for EVC100
- up to 3 padlocks Ø 8 mm for EVC250/EVCV250 (padlocks not supplied).

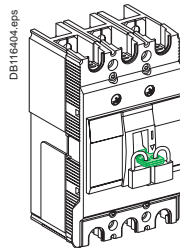

Toggle locking using a removable device:
for EVC100

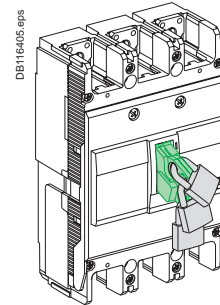

for EVC250/EVCV250

Designation	Cat. no.	
	EVC100	EVC250/EVCV250
Padlocking system	EZALOCK	-
Padlocking system for EVC250-3P	-	EZELOCK
Padlocking system for EVC250-4P and EVCV250-3/4P	-	EZELOCKN

PB1 011980-30.eps



Sealing screws

DB116406.eps

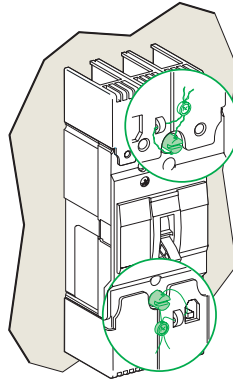

Designation	Cat. no.	
Sealing screws (set of 2)	EZC100	EZC250/EZCV250
	EZASSCR	-



AX and 2 AL.

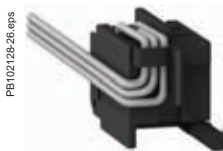

Signalling switch (AX or AL).



Double signalling switch (2 AX or 2 AL).

Plug-In location: AX - AL

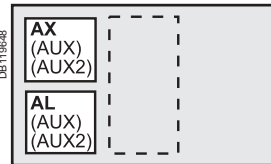

Ezc400-3P.

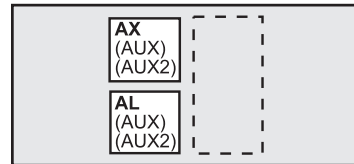

Ezc400-4P.

Indication contacts

Provide remote circuit breaker status information. They can be used for indications, electrical locking, relaying, etc. Common-point changeover contacts.

Auxiliary switch (ON/OFF)

AX indicates the position of the circuit breaker contacts.

Alarm switch (trip indication)

AL indicates that the circuit breaker has tripped due to:

- an overload
- a short-circuit
- operation of a voltage release.

It returns to de-energised state when the circuit breaker is reset.

Functions (AL or AX) is determined by the mounting location of the auxiliary

Characteristics

Contacts

Rated thermal current (A)	5			
Minimum load	10 mA at 24 V			
Utilisation category (IEC 60947-5-1)	AC12	AC15	DC12	DC14
Operational current (A)	24 V	5	4	3
	48 V	5	2.5	1
	125 V	5	0.4	0.4
	250 V	3	0.2	0.2

Connections

Connection wire length	450 mm
Cross-section	1.5 mm ²

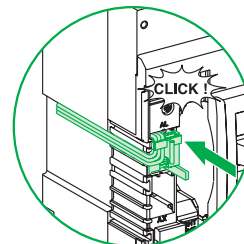
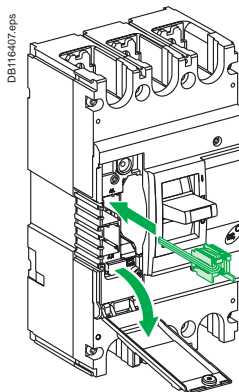

All EasyPact electrical auxiliaries are "snapped in place"

Designation

Signalling switch (AX or AL)
Double signalling switch (2 AX or 2 AL)

Cat. no.

EZ4AUX
EZ4AUX2

SHT - UVR



SHT or UVR voltage release.



Shunt Trip SHT.



Shunt Trip UVR.

Plug-In location: SHT - UVR

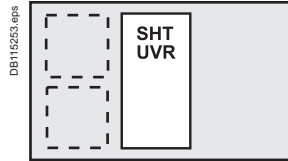

EZC400-3P.

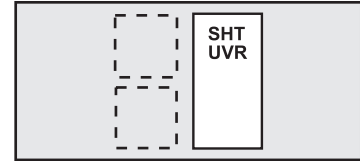

EZC400-4P.

Remote tripping

Shunt Trip (SHT) or Under Voltage Release (UVR).

Shunt Trip (SHT)

- This release trips the circuit breaker when the control voltage rises above $0.7 \times U_n$
- Control signals can be of the impulse type (≥ 20 ms) or maintained.

Under Voltage Release (UVR)

- This release trips the circuit breaker when the control voltage drops below a tripping threshold
- Tripping threshold between 0.35 and 0.7 times the rated voltage
- Circuit breaker closing is possible only if the voltage exceeds 0.85 times the rated voltage.

Operation

When the circuit breaker has been tripped by an SHT or UVR release, it must be reset locally:

- SHT or UVR tripping takes priority over manual closing
- in the presence of a standing trip order, closing of the contacts, even temporary, is not possible.

Circuit breaker tripping by an SHT or UVR release meets the requirements of standard IEC 60947-2.

Characteristics

Mechanical

Mechanical endurance 10 % of MCCB mechanical endurance

Electrical

		AC	DC
SHT	pick-up consumption	< 30 VA	< 35 W
	response time	< 50 ms	< 100 ms
UVR	seal-in consumption	< 5 VA	< 10 W
	response time	< 50 ms	< 100 ms

Connections

Connection wire length	450 mm
Cross-section	1.5 mm ²

Installation

SHT and UVR: internal mounting

Designation		Cat. no.	
SHT	AC	24-48 V	EZ4SHT048ACDC
		100-240 V	EZ4SHT200ACDC
	DC	277 V	EZ4SHT277AC
		380-480 V	EZ4SHT400AC
		24-48 V	EZ4SHT048ACDC
UVR	AC	100-220 V	EZ4SHT200ACDC
		24 V	EZ4UVR024ACDC
	DC	48 V	EZ4UVR048ACDC
		100-110 V	EZ4UVR110ACDC
		120-130 V	EZ4UVR130ACDC
UVR	AC	200-240 V	EZ4UVR200AC
		277 V	EZ4UVR277AC
	DC	380-480 V	EZ4UVR400AC
		24 V	EZ4UVR024ACDC
		48 V	EZ4UVR048ACDC
		125 V	EZ4UVR130ACDC

PB1102132-35.eps



Direct rotary handle

Suitable for Motor Control Centre (MCC) switchboards

- Degree of protection IP50, IK07.
- The direct rotary handle maintains:
 - suitability for isolation
 - indication of the three positions O (OFF), I (ON) and tripped
 - circuit breaker locking capability in the OFF position by one to three padlocks, (padlock not supplied) shackle diameter Ø8
 - door opening disabled when the circuit breaker is ON
 - circuit breaker closing is disabled if the door is open.

IP50

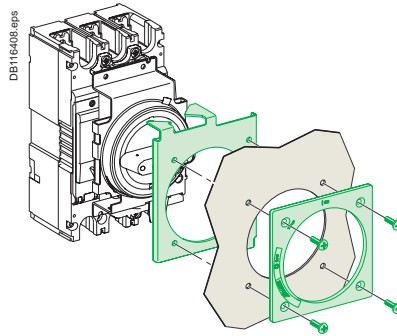

Padlocking

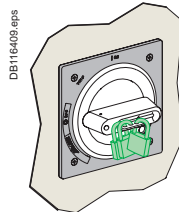

Designation

Direct rotary handle

Cat. no.

EZ4ROTDS

Extended rotary handle 400AF

PB102133488.eps



Extended rotary handle

The extended rotary handle is used to control, from the front face of the switchboard, a device installed at the back of the switchboard.

- Degree of protection IP54, IK08 (IP54 with integrated seal).
- The extended rotary handle maintains:
 - suitability for isolation
 - indication of the three positions O (OFF), I (ON) and tripped
 - circuit breaker locking capability in the OFF position by one to three padlocks, (padlock not supplied) shackle diameter: Ø8
 - door opening disabled when the circuit breaker is ON.
- The extended rotary handle is made up of:
 - a unit on the front cover of the circuit breaker (secured by screws)
 - an assembly (handle and front plate) on the door that is always secured in the same position, whether the circuit breaker is installed vertically or horizontally
 - an extension shaft that must be adjusted to the distance between of circuit breaker and door.

IP54

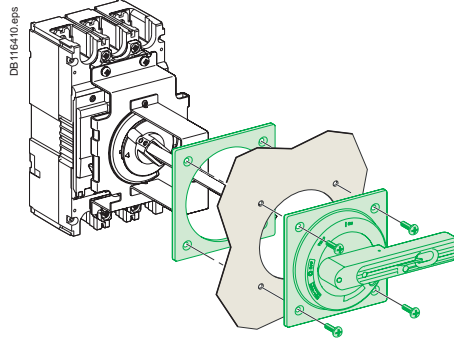

Padlocking

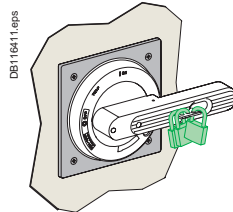

Designation

Extended rotary handle

Cat. no.

EZ4ROTE

Power connections, cable lugs, spreaders and extensions 400AF

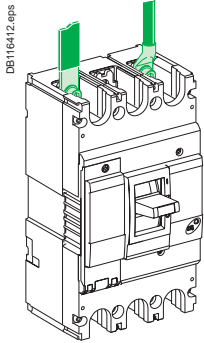

Standard circuit breaker terminals

All EasyPact circuit breakers are supplied with terminal screws

EZC400 250 to 400 A

Screw M10

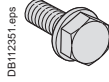

Connection of insulated bars or cables with lugs

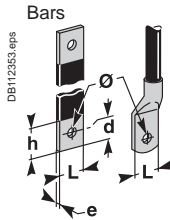

Bars	L (mm)	≤ 32
	h (mm)	d + 10
	d (mm)	≤ 10
	e (mm)	≤ 10
	Ø (mm)	10

Crimp lugs	L (mm)	≤ 32
	d (mm)	≤ 10
	Ø (mm)	10

Tightening torque 30 N.m



Cable lugs

Cable lugs directly screwed on standard circuit breaker terminals, for cables from 35 to 300 mm².

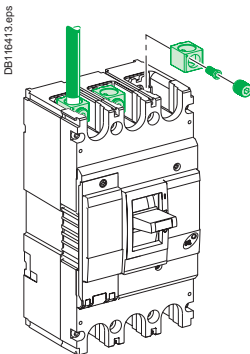

Designation	Cat. no.
Cable lug up to 400 A (set of 3)	EZ4LUG4003
Cable lug up to 400 A (set of 4)	EZ4LUG4004

Terminal extensions

Extend power connection of the EZC400 at 44 mm pitch.



Designation	Cat. no.
Extend power connection for 3-pole breaker (set of 3)	EZ4TEX3P
Extend power connection for 4-pole breaker (set of 4)	EZ4TEX3P

Spreaders

Increases the pitch of the circuit breaker terminals to 70 mm.

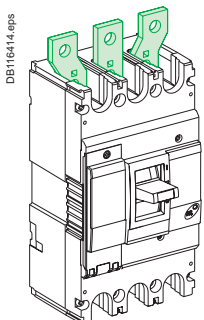

Designation	Cat. no.
Spreaders 70 mm for 3-pole breaker (set of 3)	EZ4SPDR73P
Spreaders 70 mm for 4-pole breaker (set of 4)	EZ4SPDR74P

Insulation of live parts and padlocking 400AF



PB102124-30.eps

Phase barriers

- Safety accessories for maximum insulation at the power connection points.
- Usable with all other connection accessories, except terminal shields.
- Each breaker is delivered with a set of phase barriers (2 for 3 poles and 3 for 4 poles breaker).
- Additional set of phase barriers available for insulation between outgoing or between 2 side by side mounted breakers.

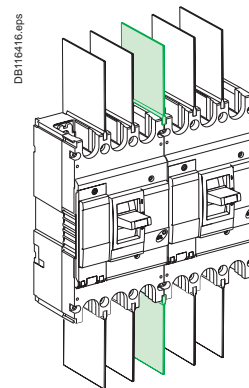
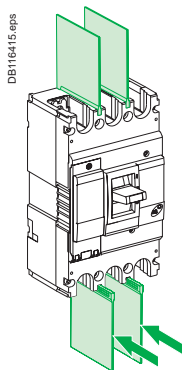

Designation

Phase barriers for 3-pole breaker (set of 2)
Phase barriers for 4-pole breaker (set of 3)

Cat. no.

EZ4FASB2
EZ4FASB3



PB102122-30.eps

Terminal shields

- Insulating accessory used for protection against direct contacts with power circuit connections. It provides a degree of protection of IP20 and a mechanical resistance of IK07.
- The long terminal shield is used with front cable or isolated busbar connections.
- Designed for 3, 4-pole EZC400.

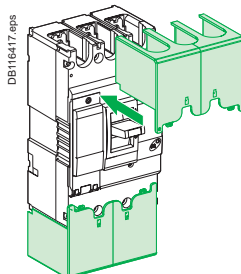

Designation

Terminal shield for 3P (set of 2 parts)
Terminal shield for 4P (set of 2 parts)

Cat. no.

EZ4TSHD3P
EZ4TSHD4P



PB102134-25.eps

Padlocking system

Locking in the OFF position guarantees isolation as per IEC 60947-2.
Padlocking system can receive up to 3 padlocks Ø8 mm (padlocks not supplied).

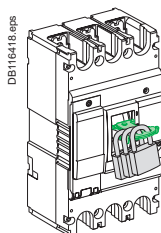

Designation

Padlocking system

Cat. no.

EZ4LOCK

<i>Presentation</i>	<i>II</i>
<i>Functions and characteristics</i>	<i>A-1</i>
Introduction	B-2
Busbars characteristics	B-4
Main busbars and extension	B-5
Accessories	
Busbar EZB250	B-7
Busbars EZB400/630	B-8
EasyPact or Compact NS branch extensions layout	B-9
<i>Installation guide</i>	<i>C-1</i>
<i>Catalogue numbers</i>	<i>D-1</i>

DB16419 eps

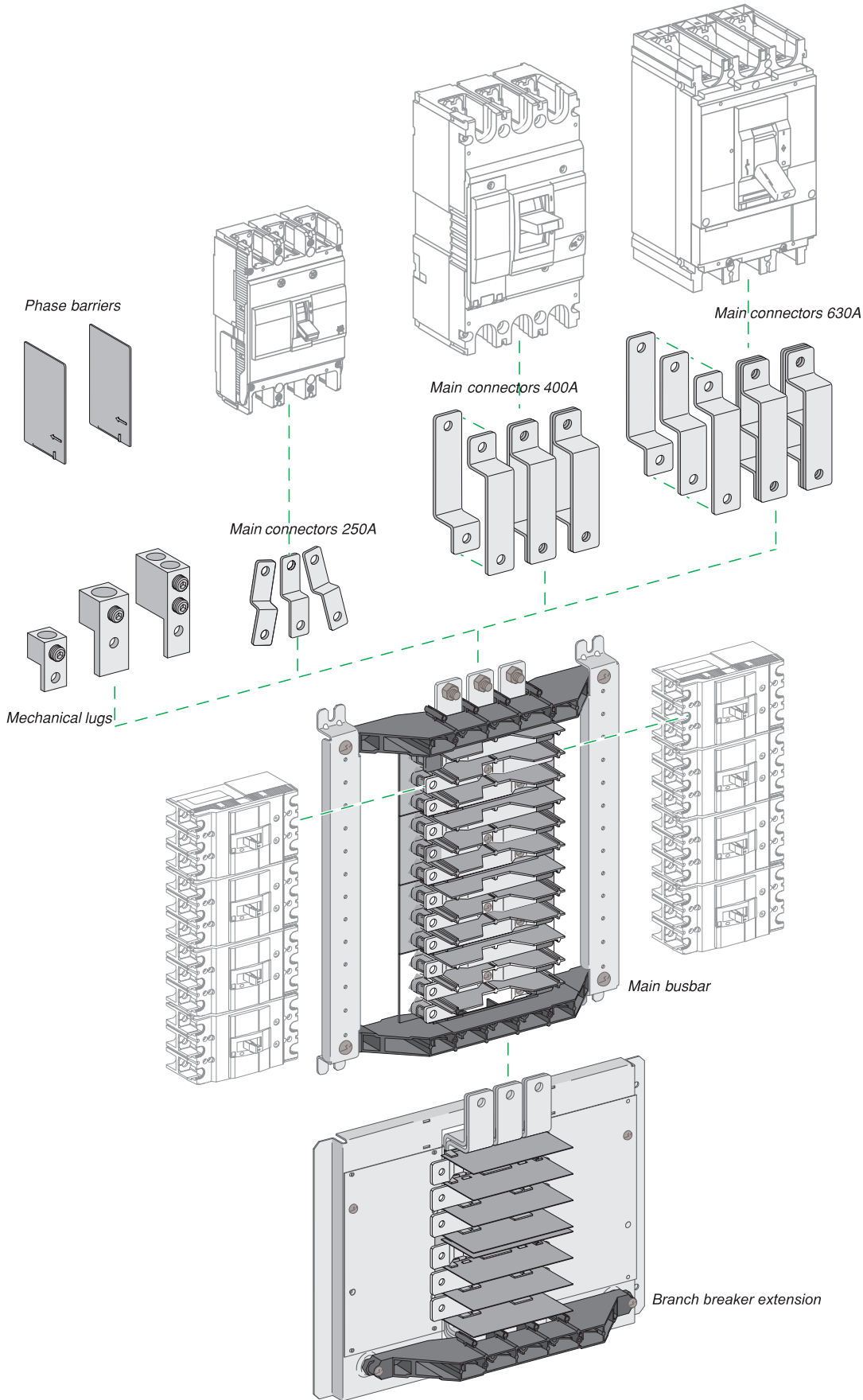

The EasyPact Busbar - engineered and certified together with the EasyPact MCCB to provide superior performance, flexibility and value. Simply the best solution for your distribution panel needs:

- available for 250 A, 400 A or 630 A main incoming current
- available for 4, 6, 8, 10 or 12 Ways (3 poles) EasyPact 100 A (max.) outgoing MCCB's
- 400 A and 630 A systems can accept an additional 2 or 4 EasyPact 250 or Compact NS250 outgoing MCCB's
- designed and tested to meet IEC 60439-1 requirements
- completely assembled in ISO certified facility for easy installation into locally made enclosures.

EZ16P-70_SE_epps

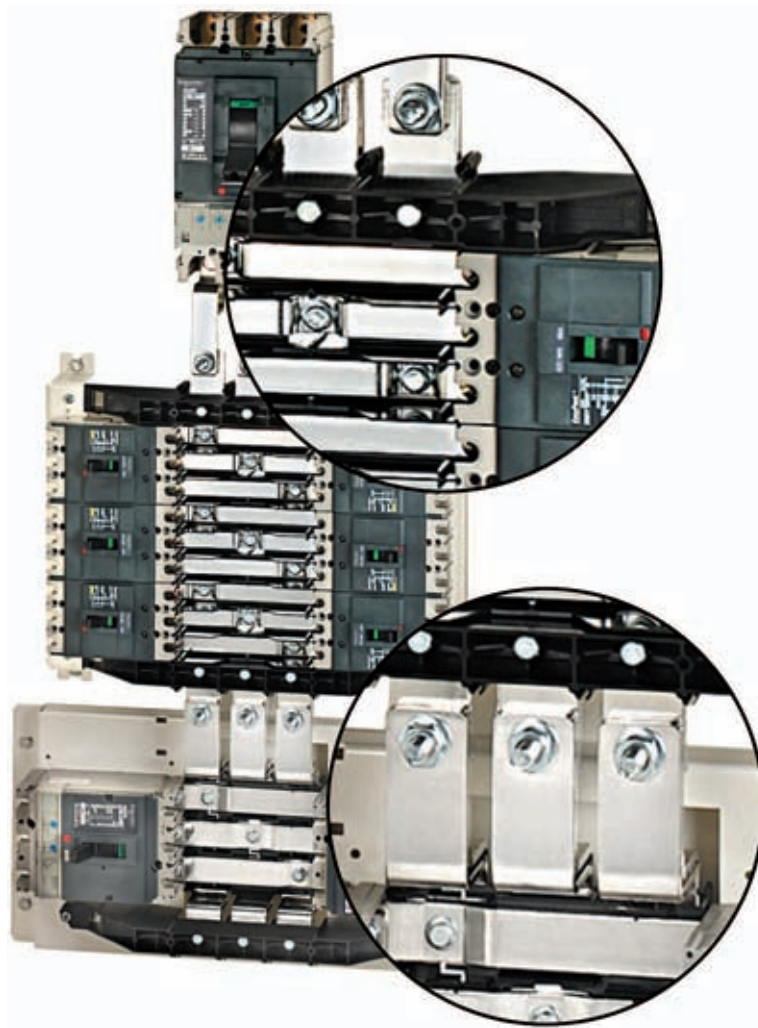

Premium Materials make a premium busbar system

- Solid copper busbars and connectors for cool, care-free operation.
- Electro-tin plating on all busbars and connectors for corrosion resistance in all environments.
- Fiberglass reinforced nylon bus supports for strength and dimensional stability.
- Molded thermoplastic phase barriers to maintain alignment and ensure electrical isolation between phases.

EZ14BP-60_3E.eps



Enclosed 10 ways Busbar 250 A with 250 A main incomer.

Compliance with standards

The EasyPact Busbar System is designed and certified to meet all international requirements specified in IEC 60439-1 relating to construction of Low Voltage switchgear and controlgear assemblies, including:

- verification of temperature - rise limits
- verification of dielectric properties
- verification of short-circuit withstand strength
- verification of clearances and creepage distances.

In addition, the system has been type-tested in ASTA labs to confirm the short-circuit and short-time withstand ratings.

EasyPact Busbar System		EZB250					EZB400					EZB630				
Number of ways		4	6	8	10	12	4	6	8	10	12	4	6	8	10	12
Numbers of outgoing (EasyPact 100)	1P	12	18	24	30	36	12	18	24	30	36	12	18	24	30	36
	2P	6	8	12	14	18	6	8	12	14	18	6	8	12	14	18
	3P	4	6	8	10	12	4	6	8	10	12	4	6	8	10	12
Extension for EZ/NS breakers		No extension					Yes (2 or 4 Ways)					Yes (2 or 4 Ways)				
Electrical characteristics																
Rated incoming current (A)		250					400					630				
Rated operational voltage (V) AC 50/60 Hz		550					550					550				
Rated insulation voltage (V)		690					690					690				
Breaking capacity		Refer to cascading tables page C-18														
Rated short-time withstand current (kA rms)	1 sec.	30					40					40				
Dimensions																
Dimensions H x W x D (mm)	4 Ways	268.5 x 416 x 82.5					290 x 416 x 107					290 x 416 x 107				
	6 Ways	343.5 x 416 x 82.5					365 x 416 x 107					365 x 416 x 107				
	8 Ways	418.5 x 416 x 82.5					440 x 416 x 107					440 x 416 x 107				
	10 Ways	493.5 x 416 x 82.5					515 x 416 x 107					515 x 416 x 107				
	12 Ways	568.5 x 416 x 82.5					590 x 416 x 107					590 x 416 x 107				

Main busbars and extension



EasyPact Busbar EZB250W08.

Main busbar

The core of the EasyPact Busbar System includes the main busbars and outgoing connectors for EasyPact MCCB's.

Designation	Cat. no.		
Type	EZB250	EZB 400	EZB630
Main busbar current rating	250 A	400 A	630 A
Number of ways			
4 ways	EZB250W04	EZB400W04	EZB630W04
6 ways	EZB250W06	EZB400W06	EZB630W06
8 ways	EZB250W08	EZB400W08	EZB630W08
10 ways	EZB250W10	EZB400W10	EZB630W10
12 ways	EZB250W12	EZB400W12	EZB630W12

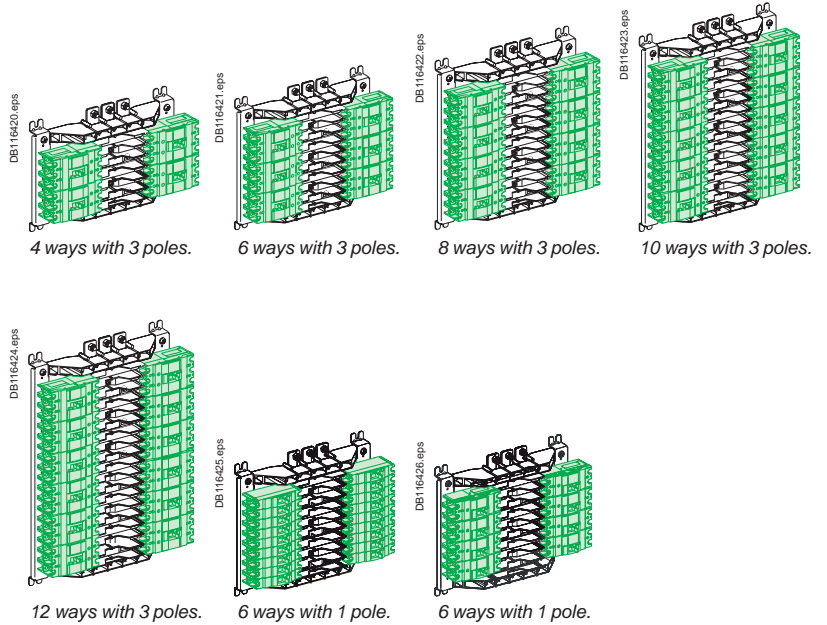

EasyPact and Compact NS branch breaker extension 2 ways.

EasyPact and Compact NS branch extension

For applications calling for larger than 100 A outgoing MCCB's, EasyPact Busbar rated 400 A and 630 A can accept the 2 ways or 4 ways EasyPact and Compact NS branch extension for up to four additional 250 A max. outgoing circuits. EasyPact and Compact NS branch extensions simply connect directly to the terminals provided on the EZB400 and EZB630 EasyPact Busbar.

Designation	Cat. no.
EZ/NS/NB branch breaker extension	
2 ways	EZBNS2
4 ways	EZBNS4

EB8301-50.eps



Main incoming connections

Incoming cables with crimped lugs can connect directly to the terminals provided.

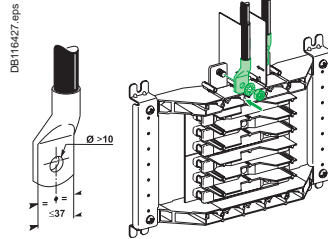

EZ17P-60_SE.eps



Main connectors

For installing a main disconnect device (EasyPact or Compact NS MCCB or INS switch) ahead of EasyPact Busbar, use the tin-plated copper connector kits below.

Designation	Cat. no.		
Main Busbar current rating	250 A	400 A	630 A
Main disconnect device for EasyPact or Compact NS or INS switch	EZB250MCNS	EZB400MCNS	EZB630MCNS

EB630P-50_SE.eps



Mechanical lugs

For incoming cables without crimped lugs, use the mechanical lug kits below. Each kit contains three aluminium lugs suitable for copper or aluminium cables.

Designation	Cat. no.		
Main Busbar current rating	250 A	400 A	630 A
Incoming cable size	16-150 mm ²	35-300mm ²	25-240 mm ² 2 cables per phase
Lug kit	EZB250MLUG	EZB400MLUG	EZB630MLUG

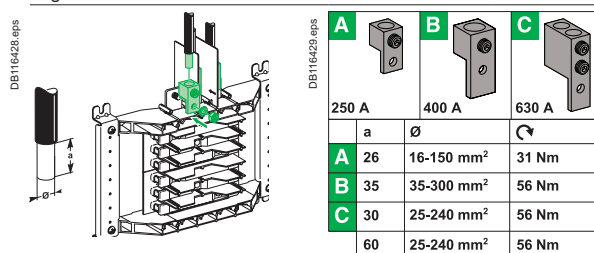

EB8310-54_SE.eps



Connector caps

Connector caps are available to isolate the ends of connectors in positions where branch breakers are not installed. Mounting screws are provided for an insulating barrier (locally provided) to cover the branch connectors when IP2X finger safety is specified.

Designation	Cat. no.
Connector caps (set of 3)	
Caps for 100 A outgoing	EZB100CAP
Caps for 250 A outgoing	EZB250CAP

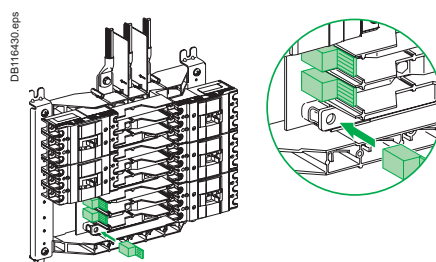

Dimensions

Busbar EZB250

Layout installation EZB250

Panel layout using the EasyPact Busbar is simple using the guides below. In addition to the mounting locations for the busbar and main disconnect components (if required), make note of the minimum clearances required to the top, bottom and sides of the enclosure.

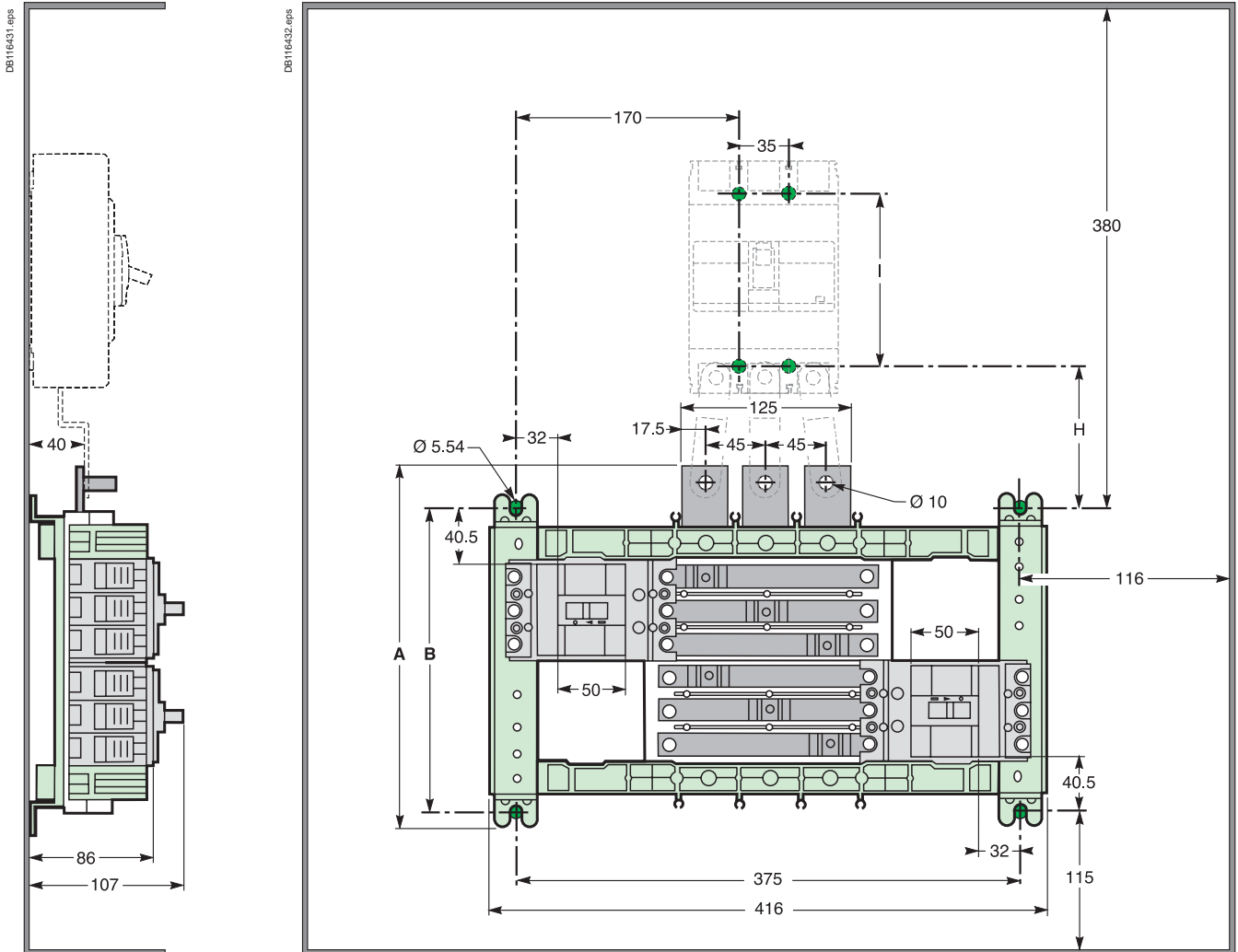

EZB250 - 250 A main busbar rating.

Trim cut-out

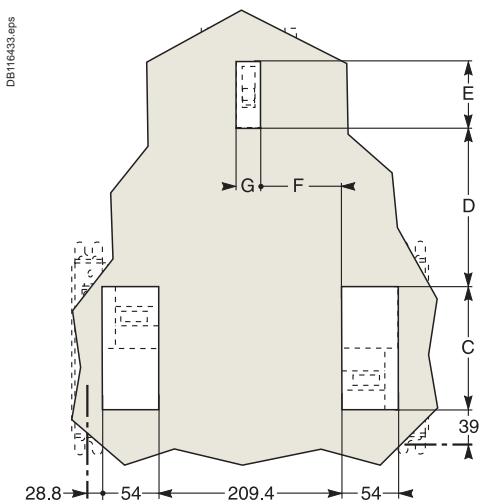

	A	B	C	D	E	F	G	H	I
EZ250 incomer	-	-	-	187.4	52	92.7	24	109.5	126
NS incomer	-	-	-	182.4	76	90.2	29	108	125
4 ways	268.5	225	147	-	-	-	-	-	-
6 ways	343.5	300	222	-	-	-	-	-	-
8 ways	418.5	375	297	-	-	-	-	-	-
10 ways	493.5	450	372	-	-	-	-	-	-
12 ways	568.5	525	447	-	-	-	-	-	-

Dimensions

Busbars EZB400/630

Layout installation EZB400/630

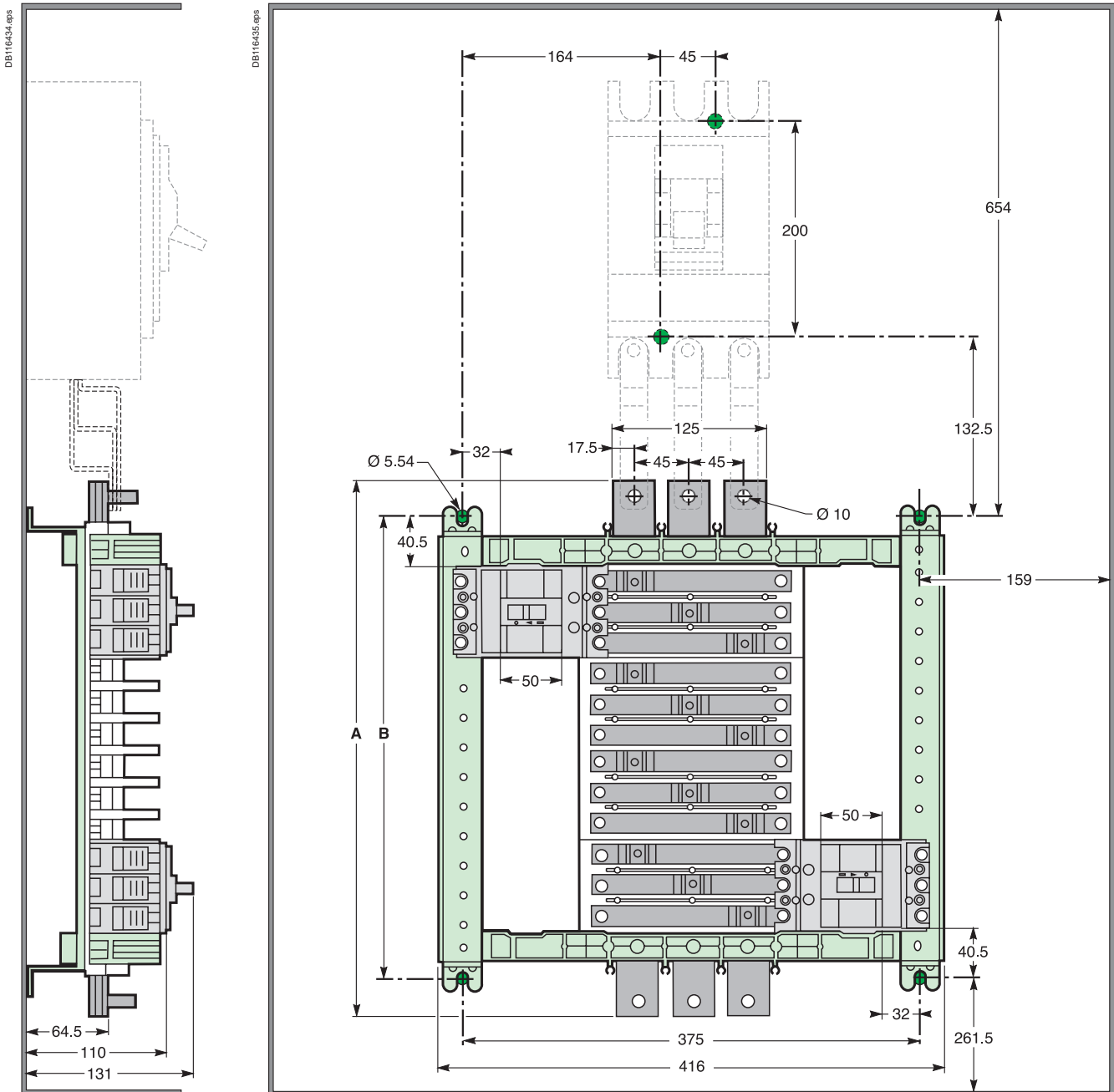

EZB400 and EZB630 - 400 A and 630 A main busbar ratings.

Trim cut-out

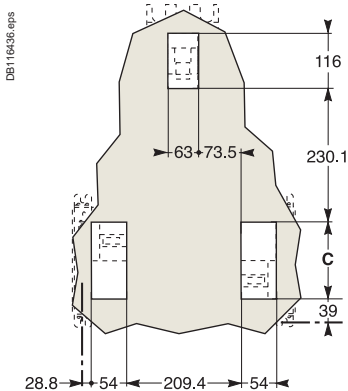

	A	B	C
4 ways	290	225	147
6 ways	365	300	222
8 ways	440	375	297
10 ways	515	450	372
12 ways	590	525	447

Note: to avoid excess temperature rise on incoming MCCB terminals, panels using 630 A main breaker with these minimum enclosure dimensions require a 7000 mm² ventilation opening (after subtracting effects of screening) at each of the 4 corners of the enclosure.

EasyPact or Compact NS branch extensions layout

Layout installation for EasyPact or Compact NS branch extensions

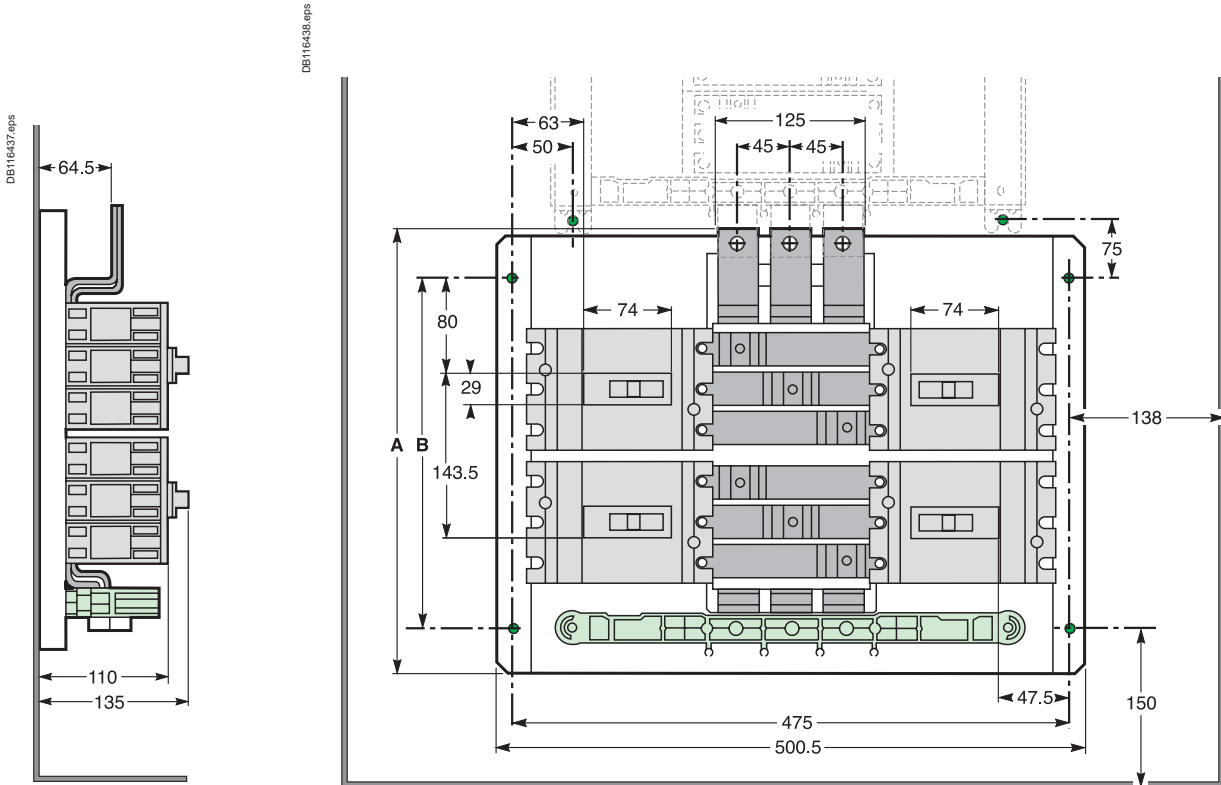

EZBNS2 and EZBNS4 Compact NS branch breaker extension.

	A	B	C	D	E	F	G	H
EZBNS2	270	175	NA	-	-	-	-	-
EZBNS4	384	275	85.5	-	-	-	-	-
EZC250	-	-	90.5	57.5	24	61	52	249
NS250	-	-	85.5	78.5	29	45.5	76	232

Trim cut-out

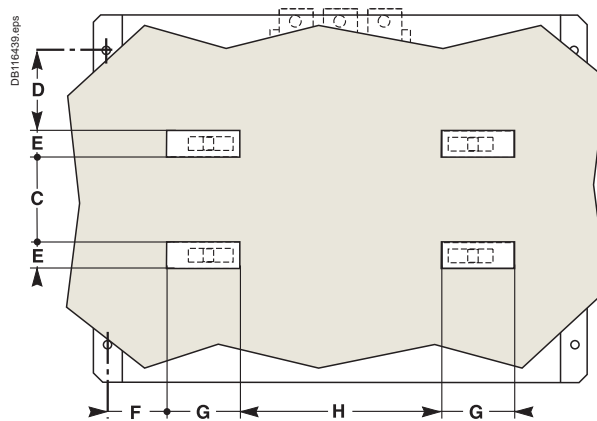

<i>Presentation</i>	<i>II</i>
<i>Functions and characteristics</i>	<i>A-1</i>
<i>Busbars</i>	<i>B-1</i>
Dimensions	
EasyPact 100	C-2
EasyPact 100 A with plug-in	C-4
EasyPact 250 - EZC250/EZCV250	C-6
EasyPact 250 A with plug-in	C-8
EasyPact 400	C-10
EasyPact 100 accessories	C-12
EasyPact 250 accessories	C-13
EasyPact 400 accessories	C-14
Safety clearances and minimum distances	C-15
Temperature derating	C-17
Tripping curves	C-18
Current-limiting curves	C-20
Cascading	C-21
Cascading tables	C-22
Motor protection	C-24
Capacitor protection	C-26
<i>Catalogue numbers</i>	<i>D-1</i>

Dimensions

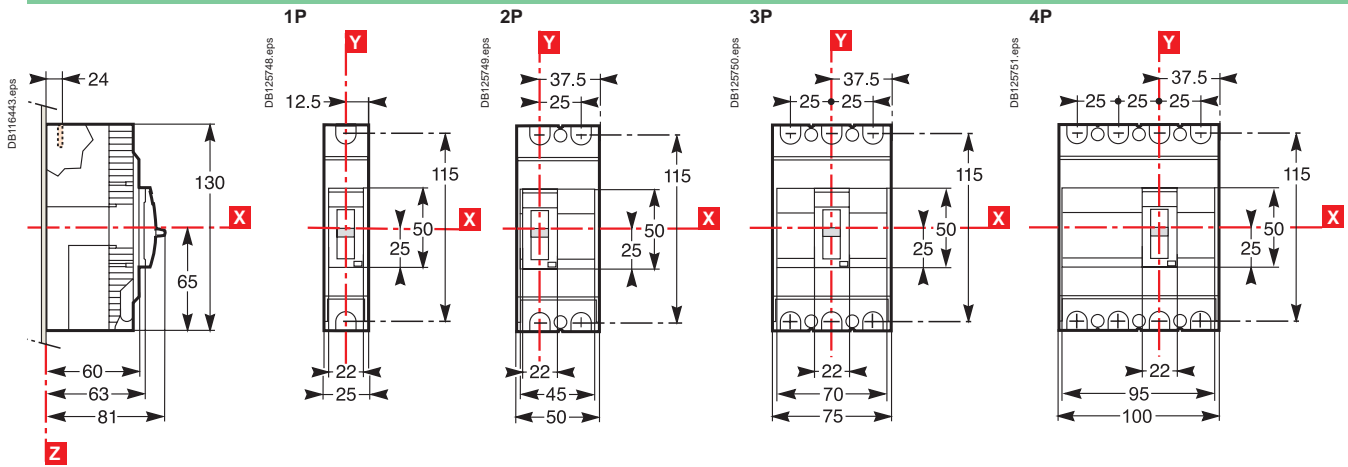

Mounting on plate

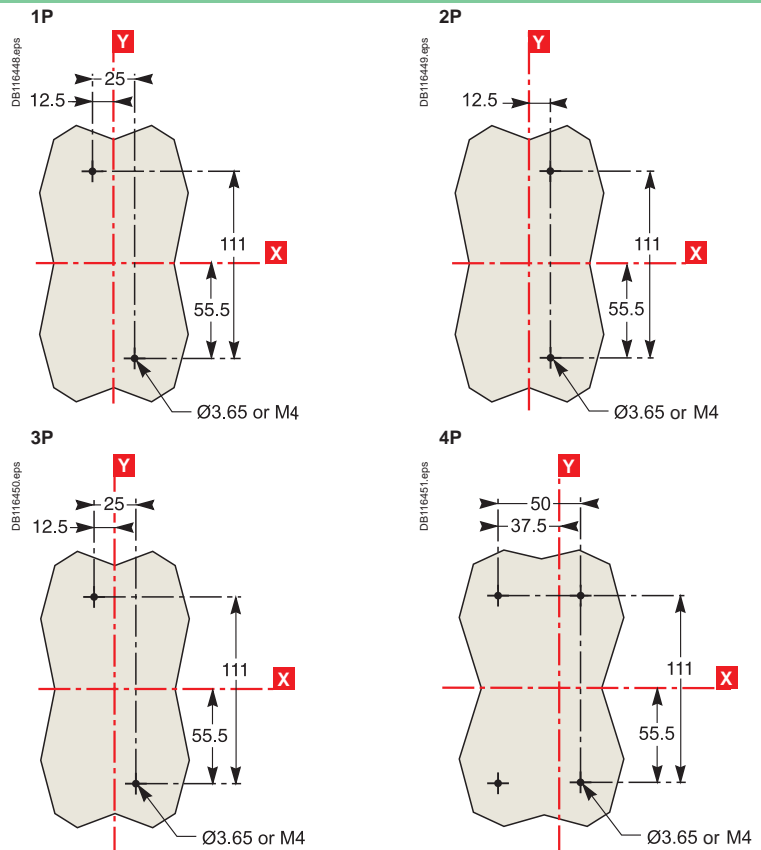

Mounting on DIN rail

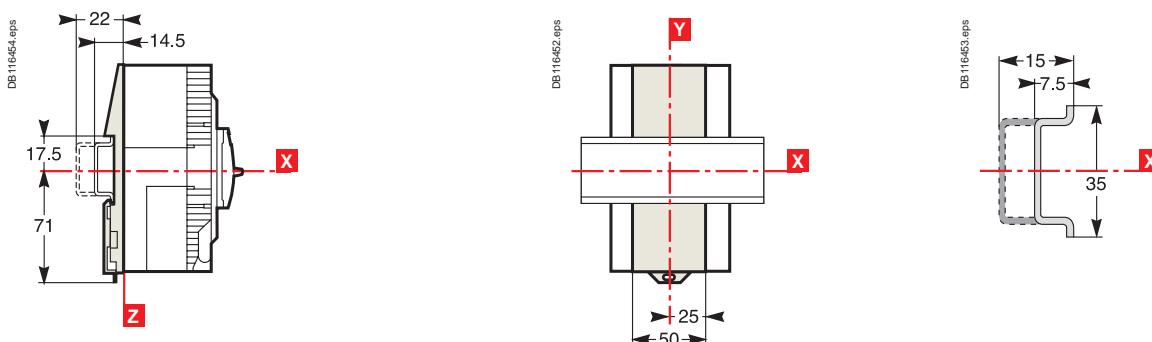

Door cut-out (small)

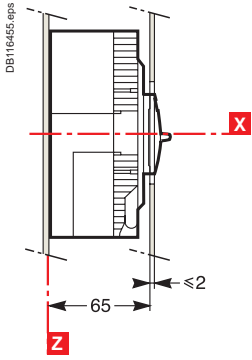

1P, 3P

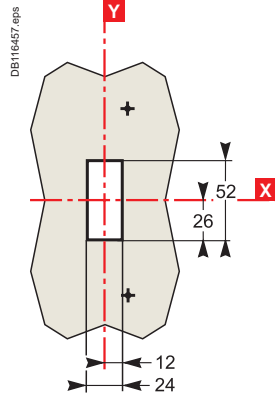

2P

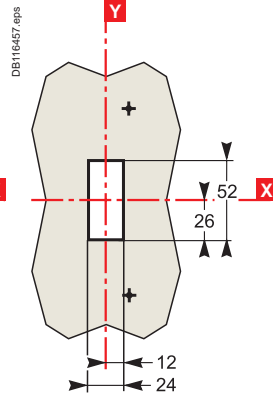

4P

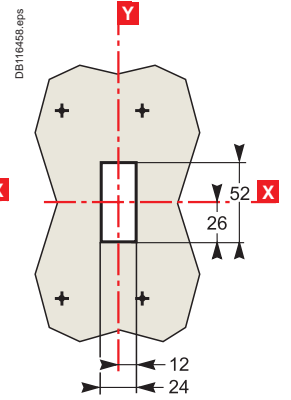

Door cut-out (large)

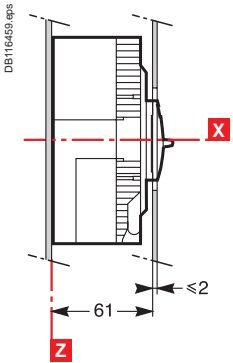

1P

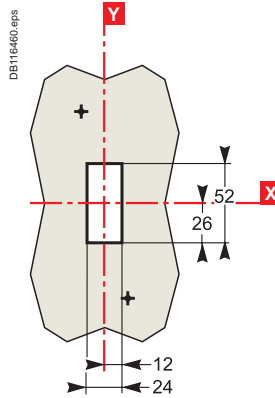

2P

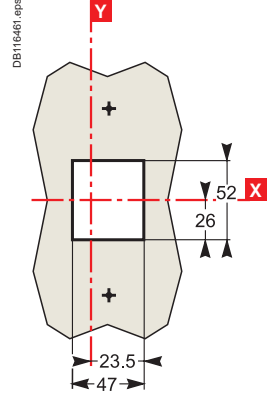

3P

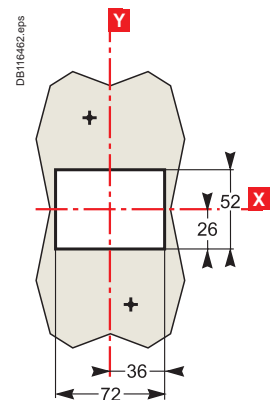

4P

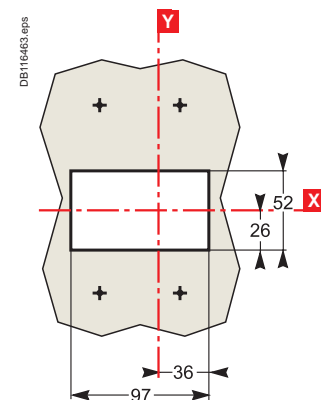

Dimensions

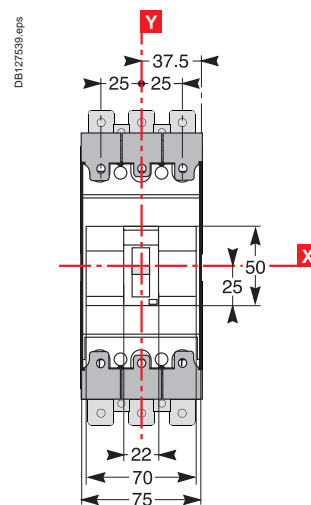
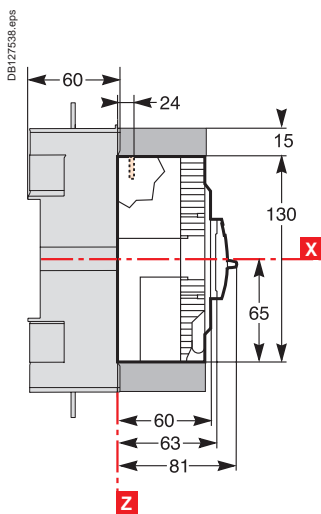
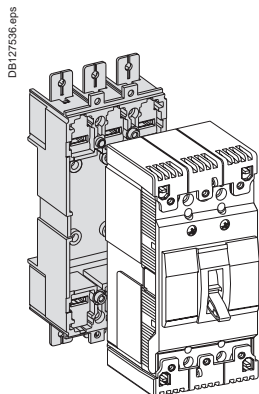

Mounting

Through front panel

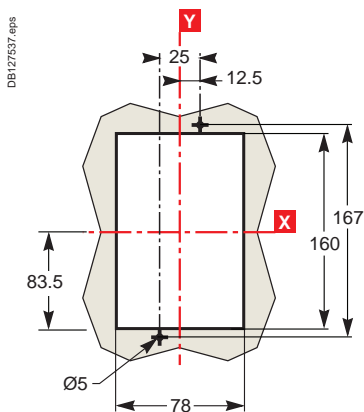
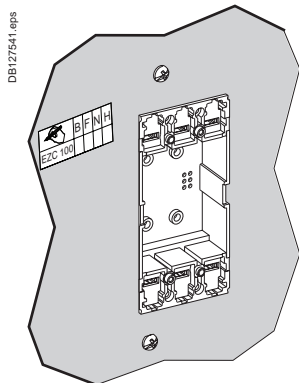

On rail

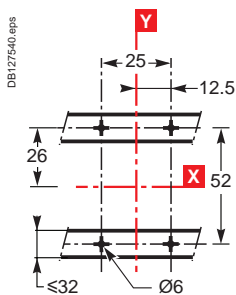
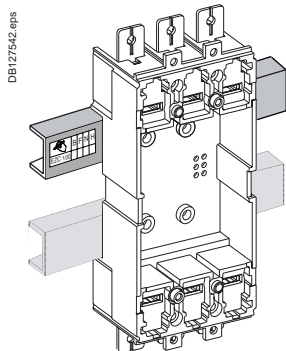

On backplate

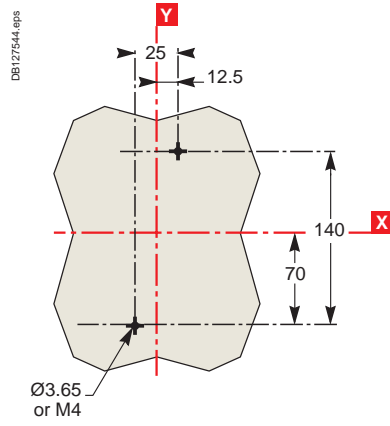
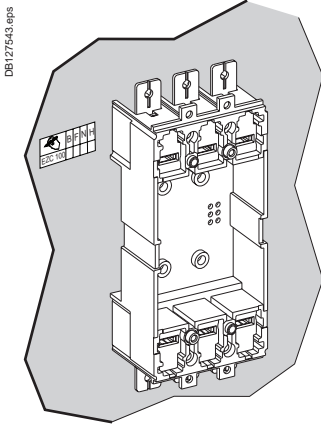

Dimensions - combination

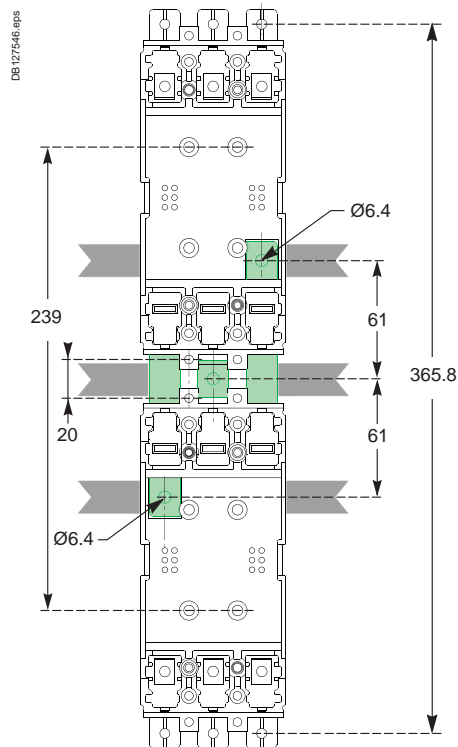
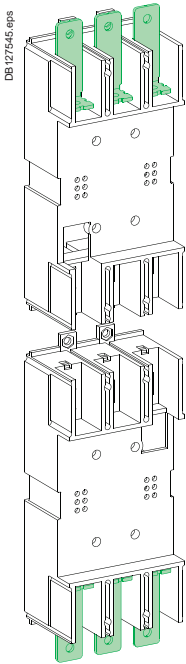

Dimensions

EasyPact 250

EZC250/EZCV250

Dimensions (EZC250)

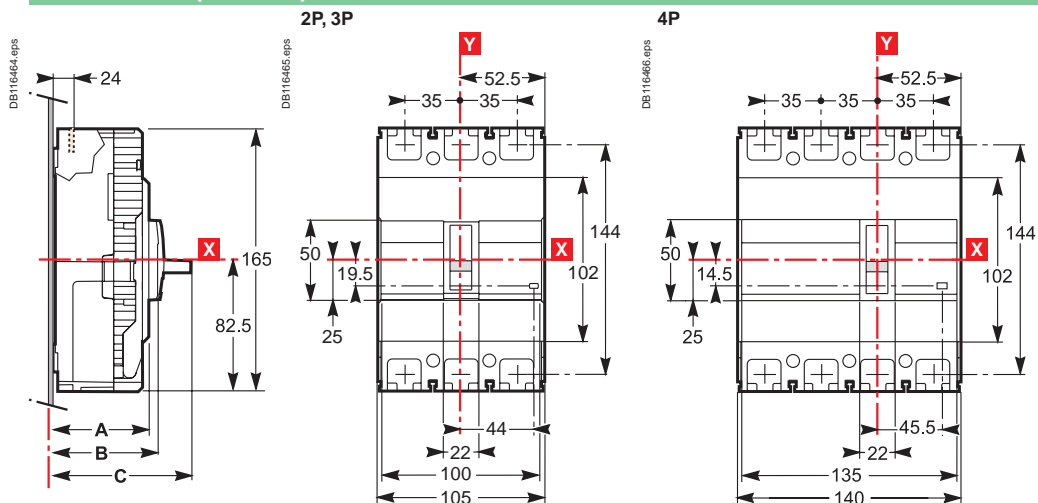

Dimensions (EZCV250)

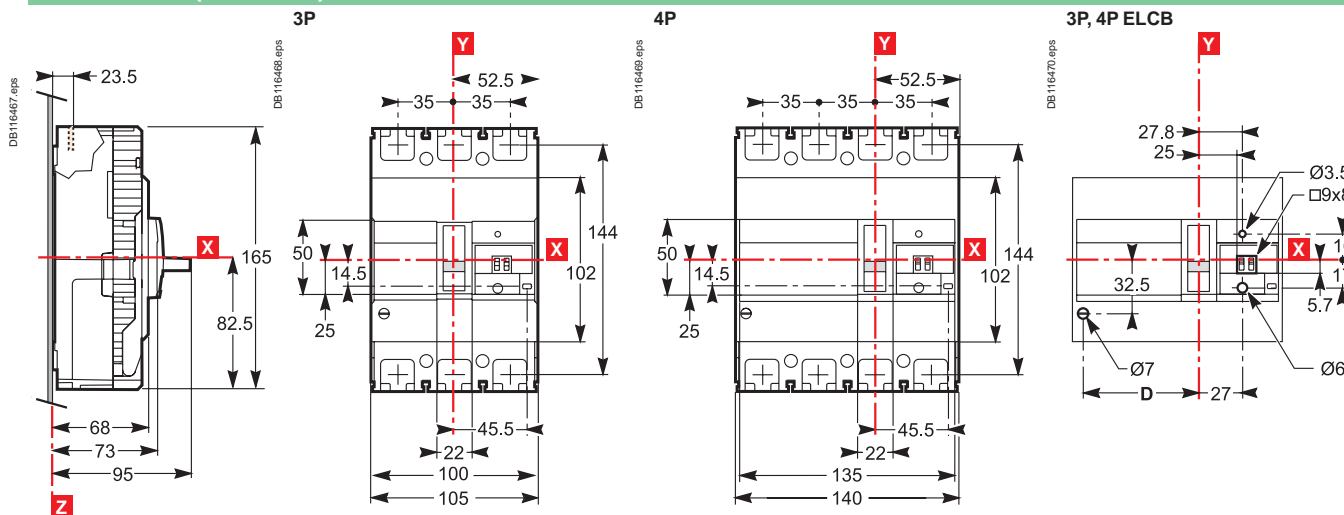

Mounting on plate

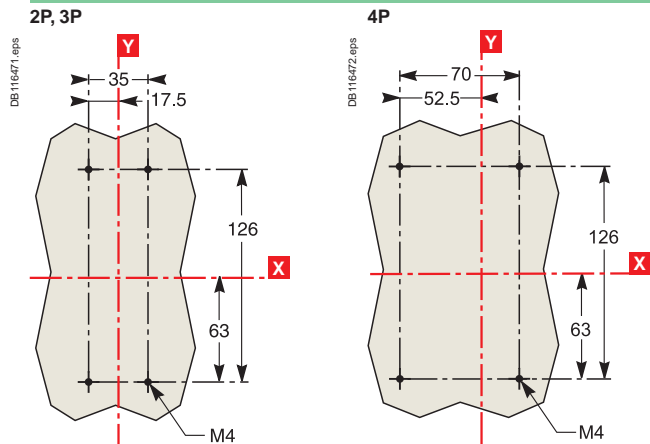

Door cut-out (small)

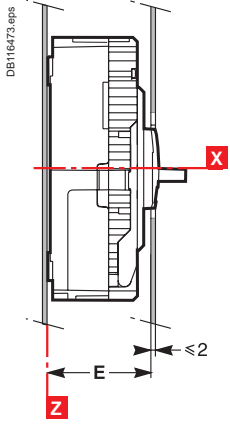

2P, 3P

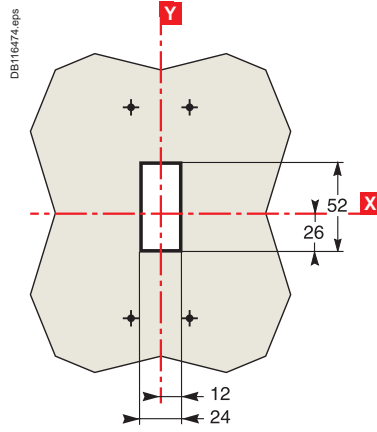

4P

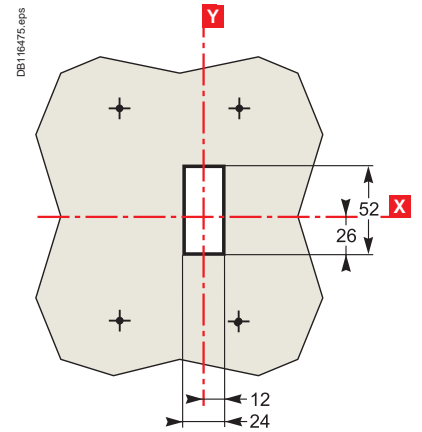

Door cut-out (large)

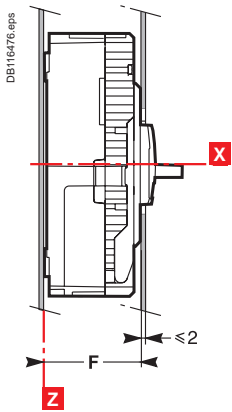

2P, 3P

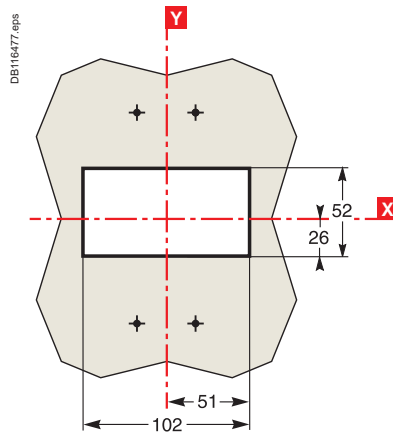

4P

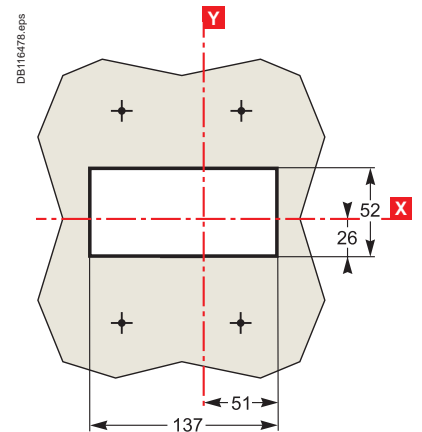

Dimensions (mm)

	A	B	C	D	E	F
EZC 2/3P	60	65	85.5	-	67	61
EZC 4P	68	73	95	-	75	69
EZCV 3P				45.5		
EZCV 4P				80.5		

Dimensions

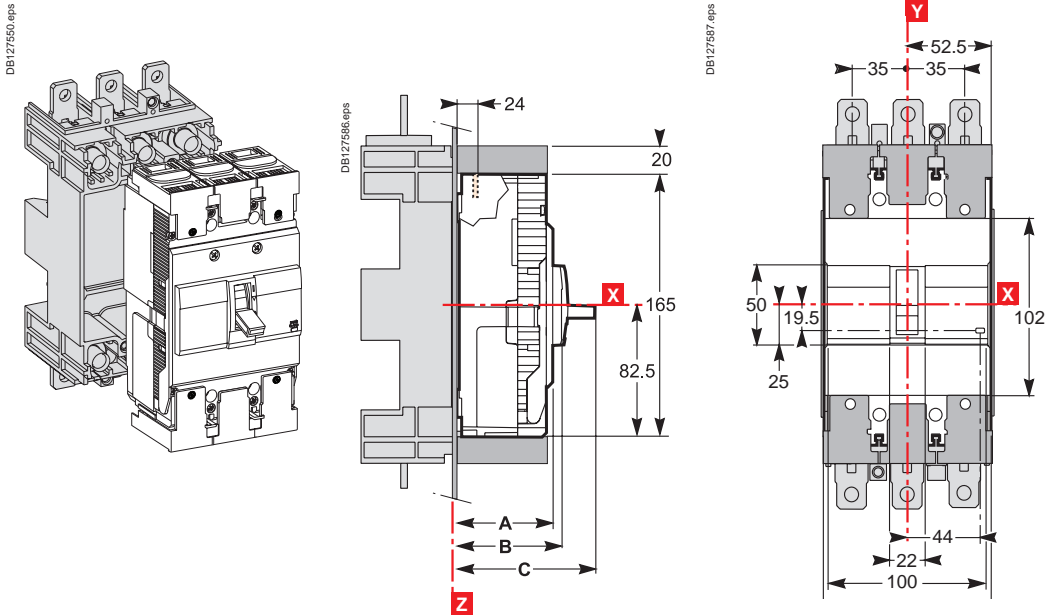

Mounting

Through front panel

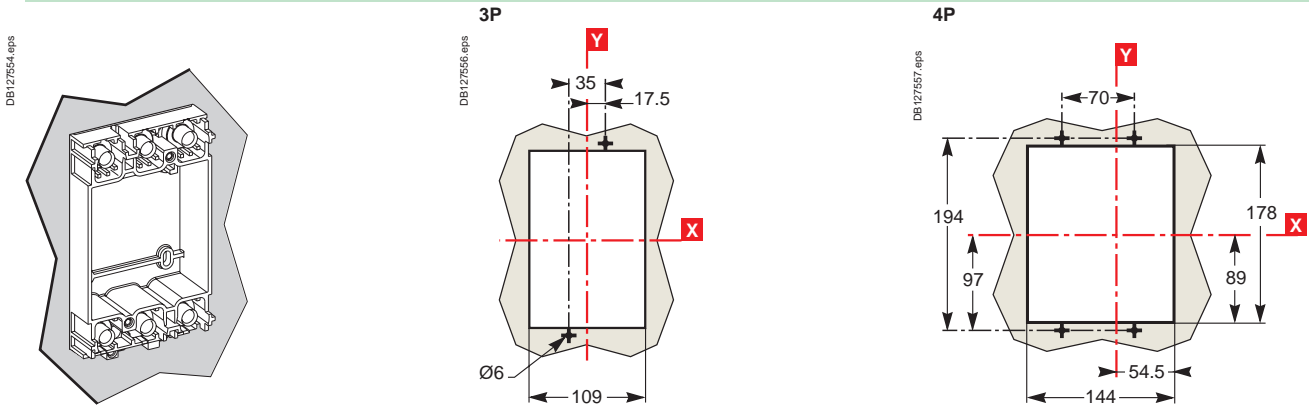

On rail

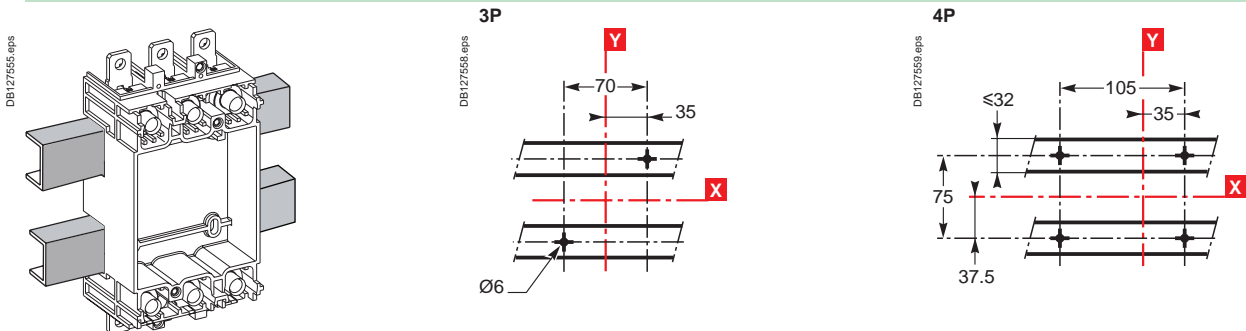

On backplate

DBE127560.eps

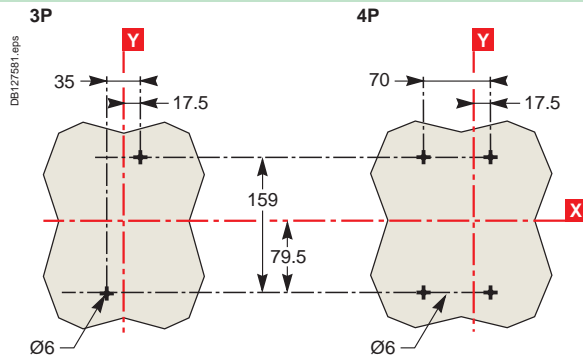
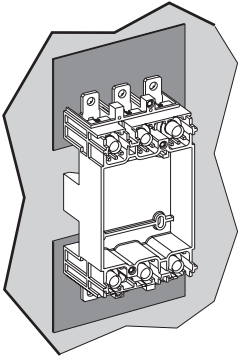

Dimensions

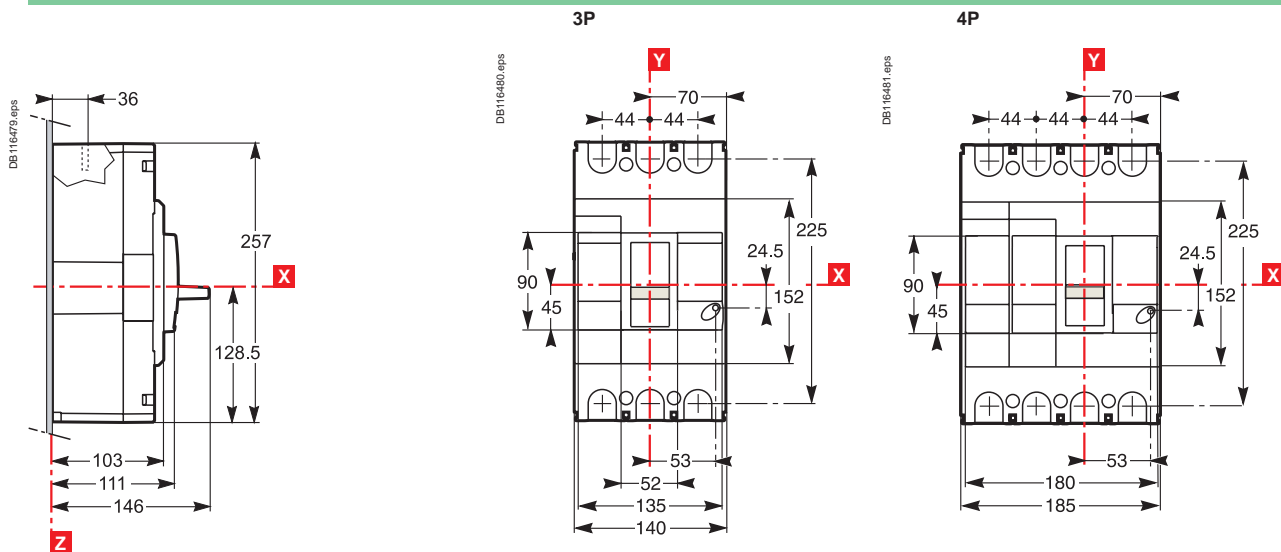

Mounting on plate

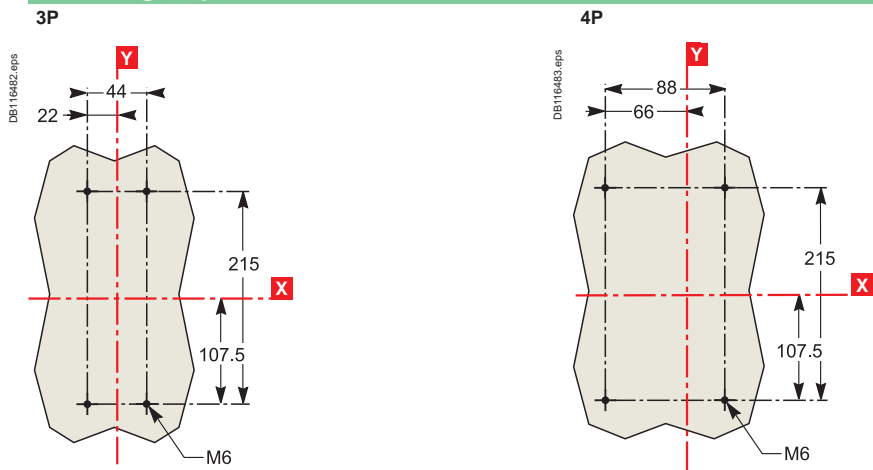

Door cut-out (small)

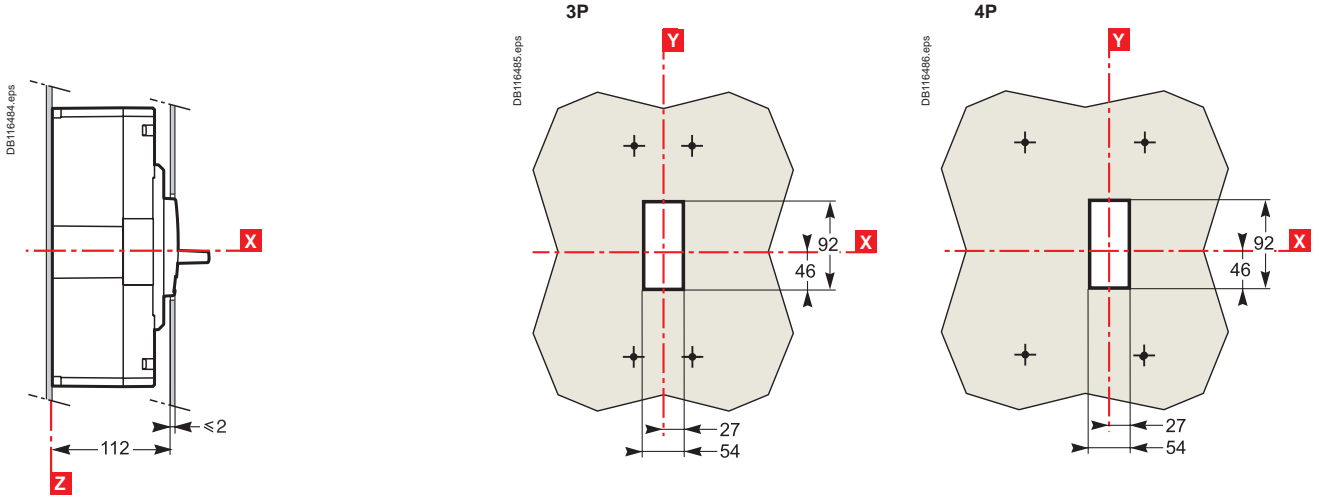

Door cut-out (large)

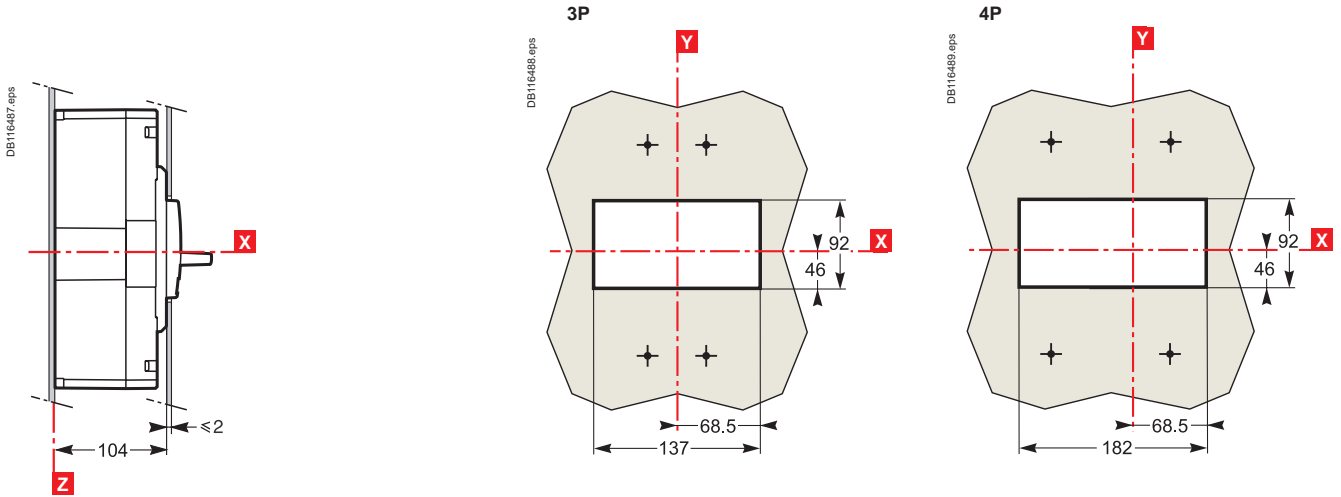

Terminal shields

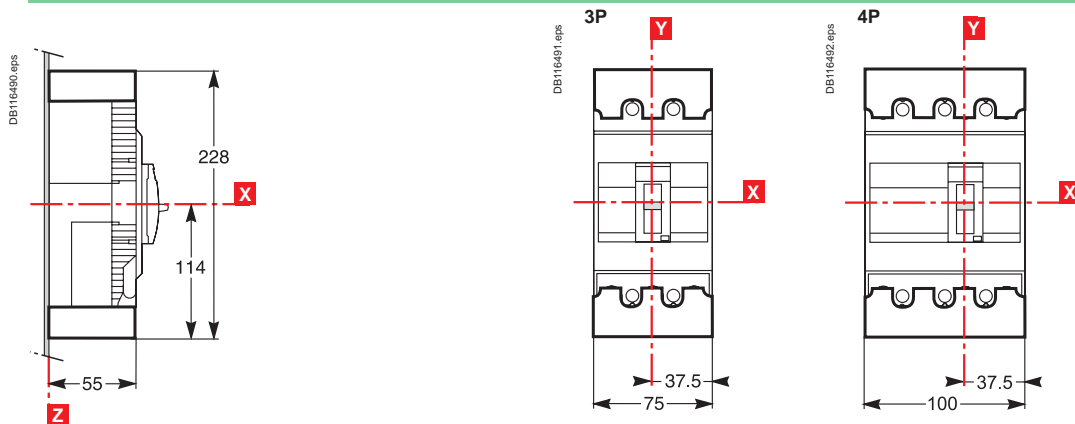

Phase barriers

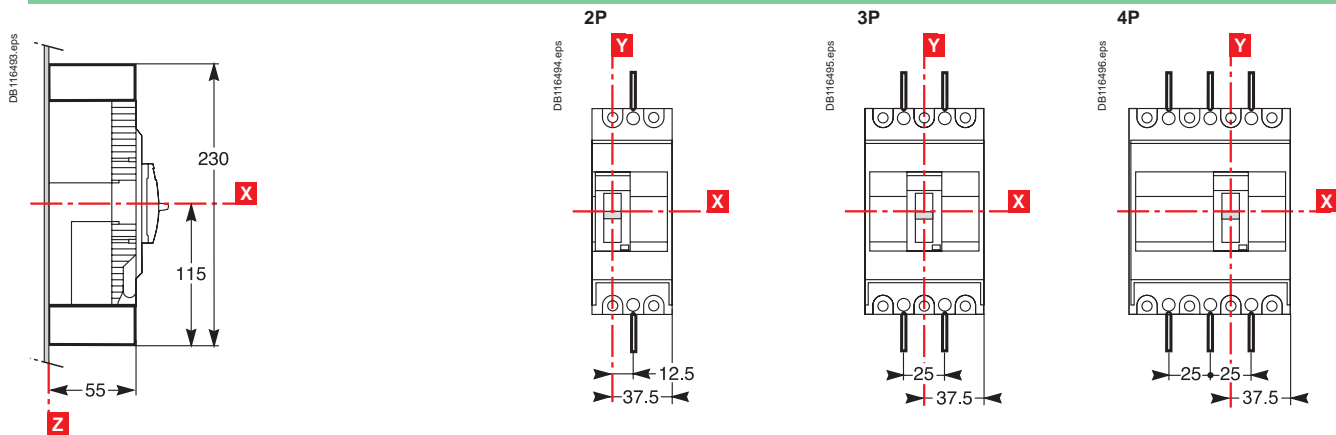

Direct rotary handle

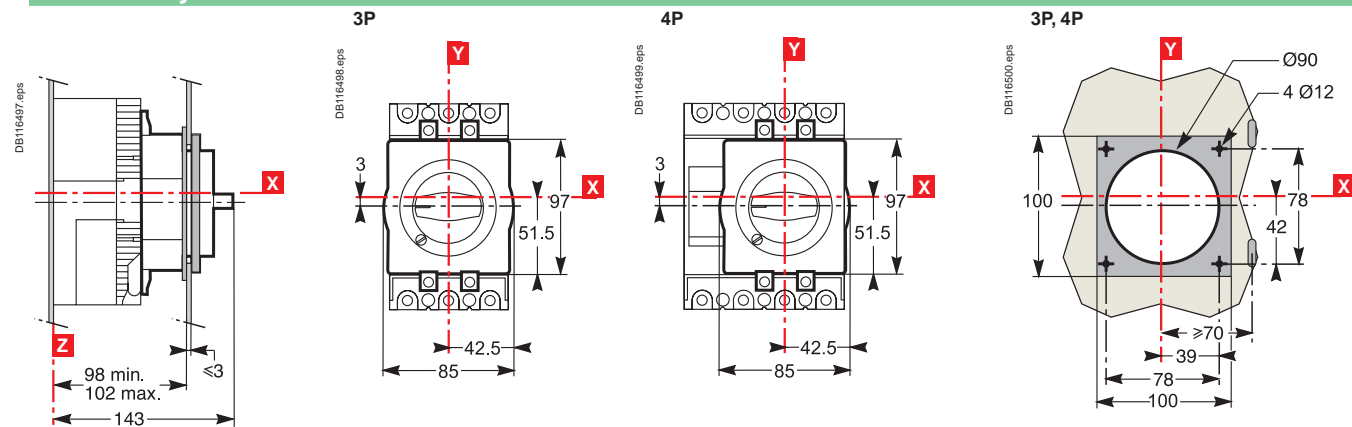

Extended rotary handle

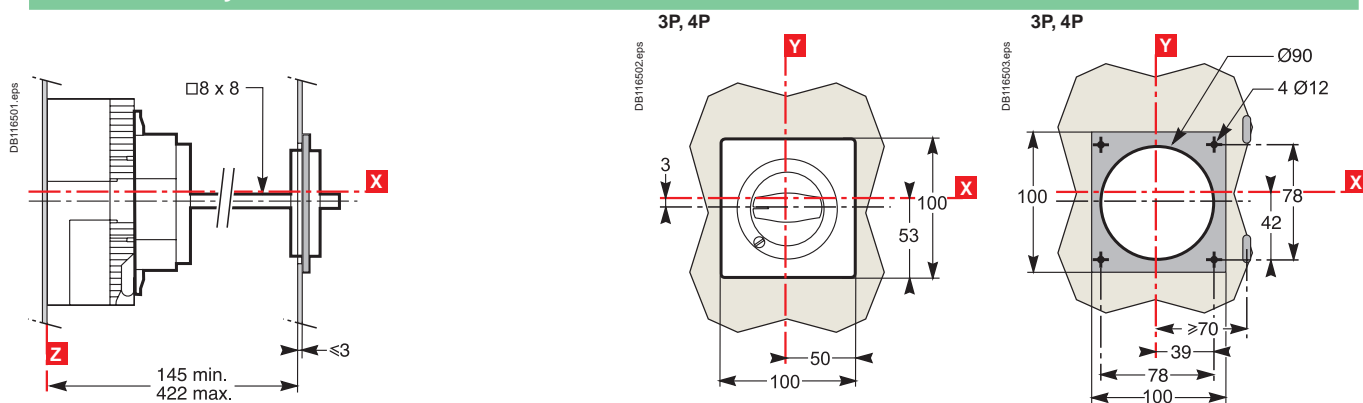

EasyPact 250 accessories

Terminal shields

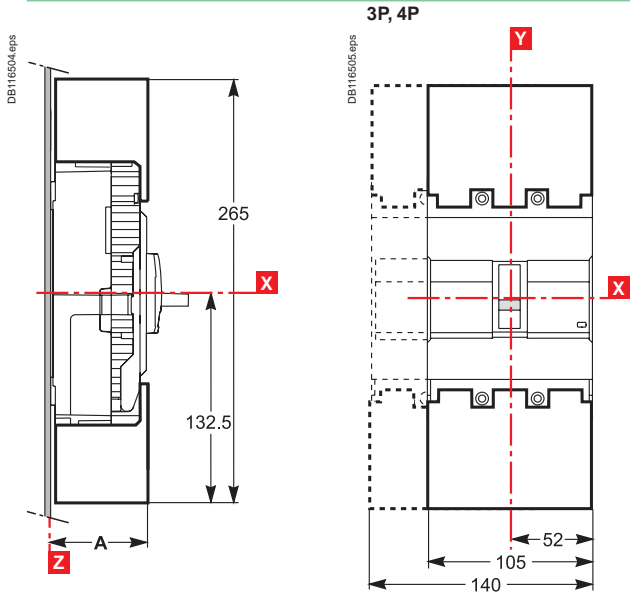

Phase barriers

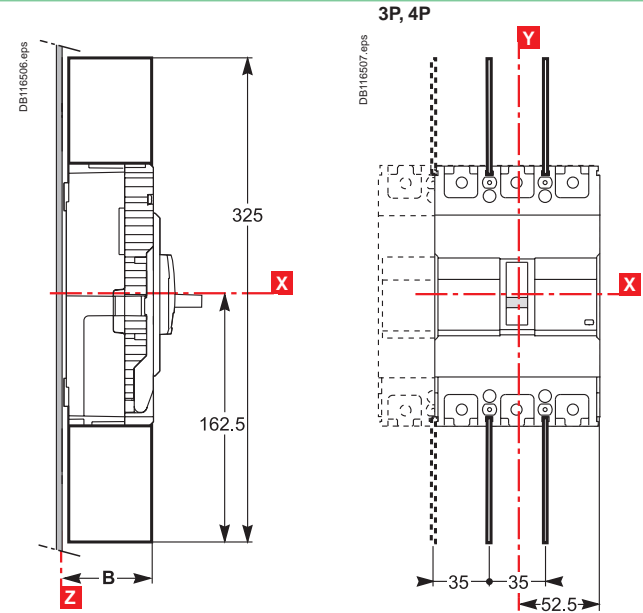

Direct rotary handle

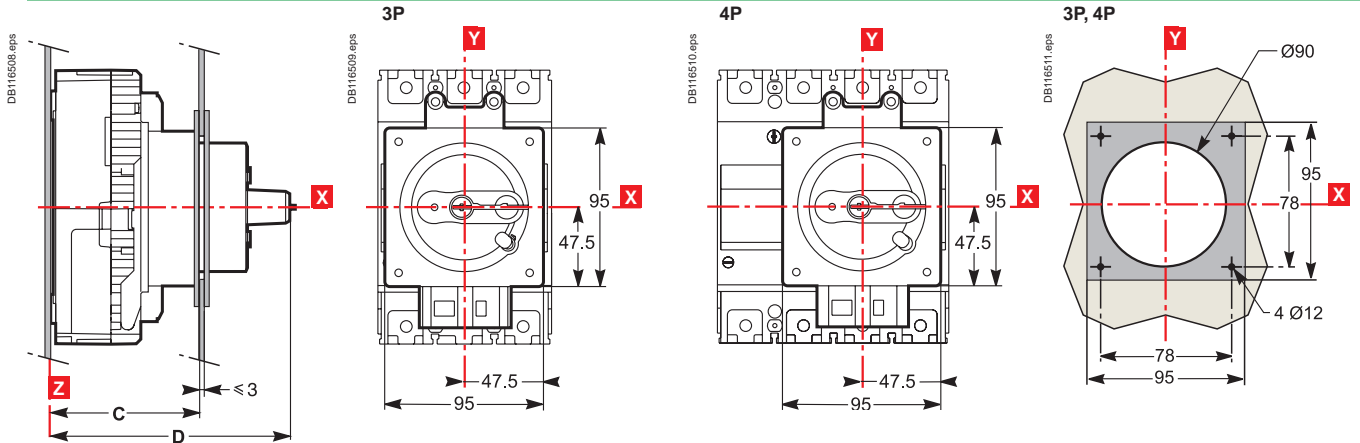

Extended rotary handle

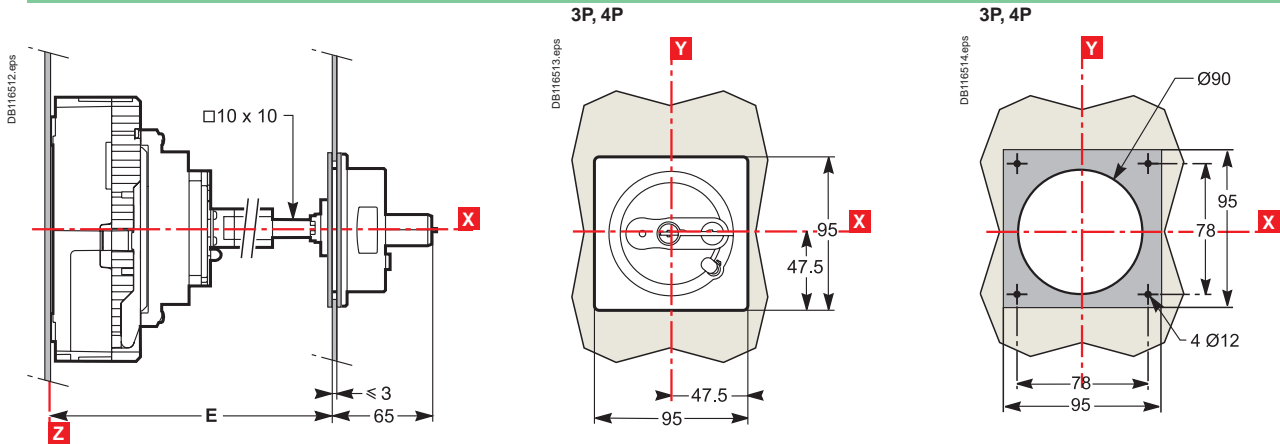

Dimensions (mm)

	A	B	C	D	E
EZC 2/3P	58.5	55	93 to 97	145	137 to 414
EZC 4P	66.5	63	101 to 105	153	145 to 422
EZCV 3P/4P					

Terminal shields

Phase barriers

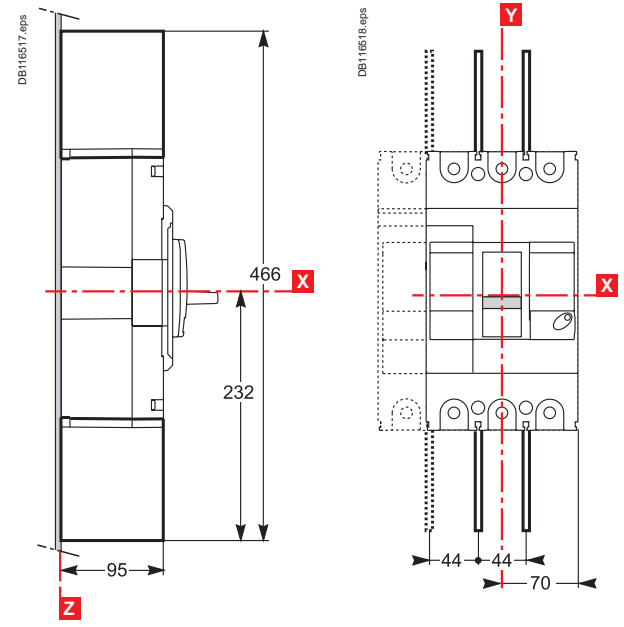
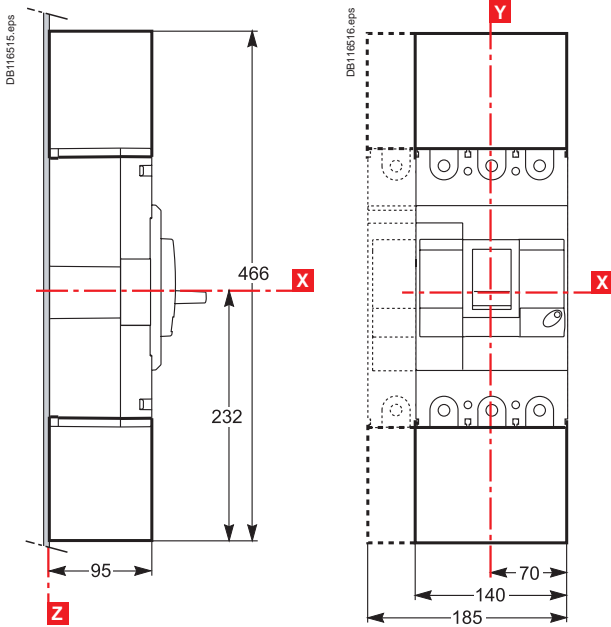

Direct rotary handle

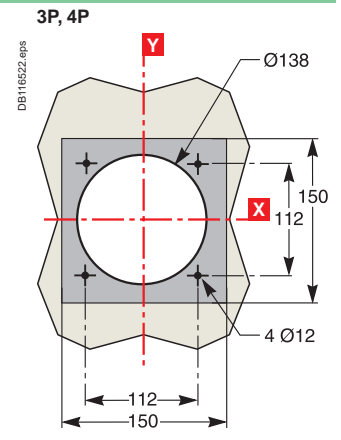
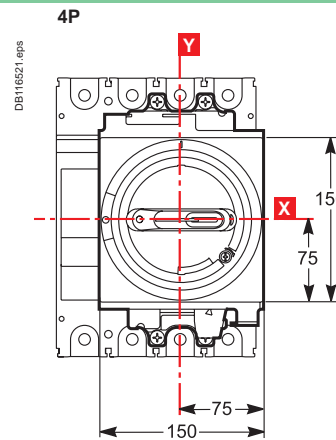
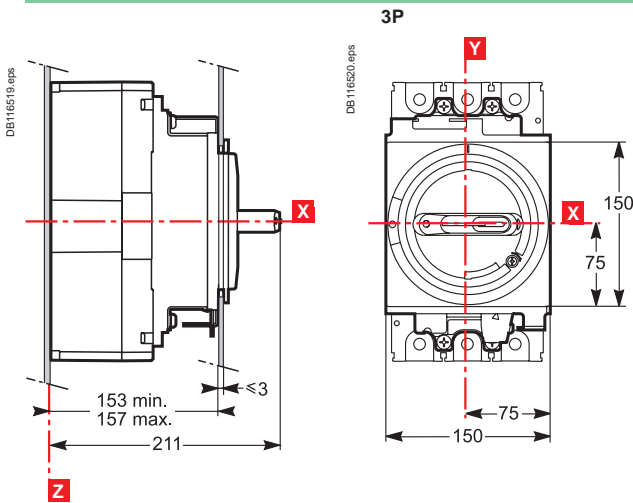

Extended rotary handle

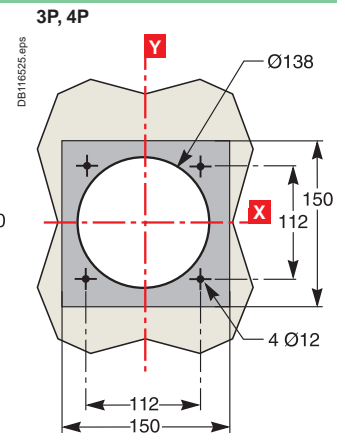
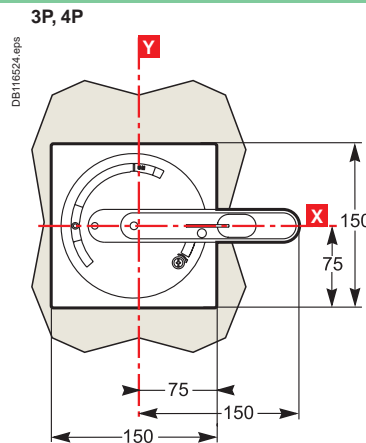
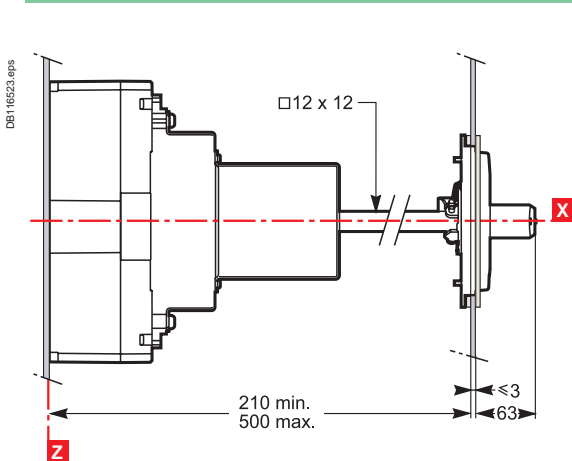

Safety clearances and minimum distances

When installing a circuit breaker, minimum distances (safety clearances) must be maintained between the device and panels, bars and other protection devices installed nearby. These distances, which depend on the ultimate breaking capacity, are defined by tests carried out in accordance with standard IEC 60947-2.

If installation conformity is not checked by type tests, it is also necessary to:

- use insulated bars for circuit-breaker connections
- block off the busbars using insulating screens.

For EasyPact breaker, terminal shields, inter-phase barriers or an insulation isolator are recommended and may be mandatory depending on the utilisation voltage and the type of installation.

Minimal distance between two adjacent circuit breakers

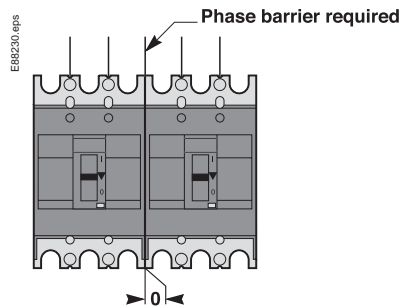

Minimal distance between the circuit breaker and top, bottom or side panels

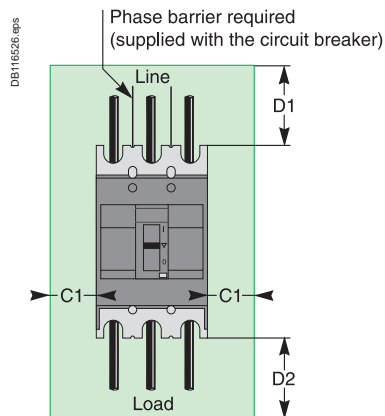

Minimal distance between the circuit breaker and front or rear panels

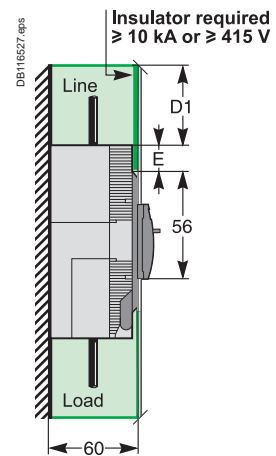

Dimensions (mm)	Bare or painted sheet metal:					
	C1	insulated bars		bare busbar under voltage		
		D1	D2	D1	D2	E
EasyPact circuit breaker						
EZC100B/F/N	40	45	45	75	45	40
EZC100H	40	60	45	75	45	40
EZC250F/N-EZCV250N	50	60	45	140	45	42.5
EZC250H-EZCV250H	50	80	45	140	45	42.5
EZC400N	50	120	100	250	100	40
EZC400H	80	140	100	250	100	40

The mandatory distances when installing EasyPact circuit breakers are calculated from the device case, not taking into account the terminal shields or the phase barriers.

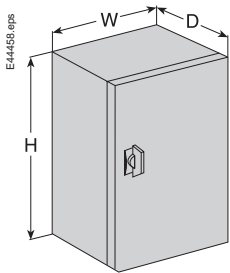

Installation in an enclosure.

Installation in an enclosure

EasyPact circuit breakers can be installed in a metal enclosure together with other devices (contactors, motor-protection circuit breakers, LEDs, etc.).

Minimum enclosure dimensions (3P)

Circuit breakers	Height (mm)	Depth (mm) ⁽¹⁾	Width (mm)
EZC100B/F/N	200	90	155
EZC100H	215	90	155
EZC250F/N-EZCV250N	270	90	205
EZC250H-EZCV250H	290	90	205
EZC400N	480	160	240
EZC400H	500	160	300

(1) With front door.

Temperature derating

Ambient temperature

EasyPact devices are equipped with fixed thermal-magnetic trip units.

- EasyPact has been particularly designed to hold 100 % In at 50 °C without tripping in normal condition (except for earth-leakage circuit breakers).
- EasyPact circuit breakers may be used between -25 °C and +70 °C.
- EasyPact circuit breakers should be put into service under normal ambient operating temperature conditions. Exceptionally, the circuit breaker may be put into service when the ambient temperature is between -35 °C and -25 °C.
- the permissible storage-temperature range for EasyPact circuit breakers in the original packing is -35 °C to +85 °C.

To determine tripping times using time/current curves, use Ir values corresponding to the thermal setting on the device, corrected as indicated in the tables below.

Rated current (A)	25 °C	40 °C	45 °C	50 °C	55 °C	60 °C	65 °C	70 °C
EZC100								
15	17.0	15.7	15.3	15.0	14.7	14.6	14.2	13.8
16	18.1	16.7	16.3	16.0	15.7	15.6	15.1	14.7
20	21.8	20.4	20.2	20.0	19.7	19.2	18.9	18.5
25	26.9	25.7	25.3	25.0	24.7	24.5	24.3	24.0
30	34.5	31.4	30.7	30.0	29.4	29.1	28.5	28.0
32	36.8	33.5	32.7	32.0	31.4	31.0	30.4	29.9
40	42.8	40.9	40.4	40.0	39.5	38.0	37.6	37.1
45	48.8	46.9	45.9	45.0	44.4	43.3	42.6	41.9
50	54.2	52.1	51.0	50.0	49.3	48.1	47.3	46.6
60	64.4	61.8	60.9	60.0	59.0	57.5	56.6	55.7
63	67.6	64.9	63.9	63.0	62.0	60.4	59.4	58.5
75	78.6	76.8	75.9	75.0	73.5	70.4	69.8	69.1
80	84.4	82.2	81.1	80.0	78.6	77.3	76.7	76.1
100	109	103	101	100	99	94	94	93
EZC250								
63	77	69	66	63	60	56	53	49
80	93	86	83	80	77	74	71	68
100	115	106	103	100	96	93	89	85
125	148	135	130	125	120	114	109	103
150	174	160	155	150	145	139	134	128
160	186	171	166	160	154	148	142	136
175	207	188	182	175	168	161	153	145
200	236	215	208	200	192	184	175	166
225	268	244	235	225	215	205	194	182
250	297	270	260	250	239	228	215	203
EZCV250								
63	72	63	60	56	53	49	44	39
80	89	80	77	73	70	66	62	58
100	113	100	95	91	86	80	74	68
125	140	125	120	114	108	102	95	88
150	163	150	145	141	136	131	125	120
160	177	160	154	148	141	135	127	120
175	194	175	168	161	154	146	138	126
200	223	200	192	183	175	165	155	144
225	245	225	218	211	203	196	180	162
250	277	250	240	230	220	209	198	180
EZC400								
250	293	268	260	250	240	228	218	208
300	351	321	312	300	288	273	261	249
320	374	342	333	320	307	291	278	266
350	410	375	364	350	336	319	305	291
400	468	428	416	400	384	364	348	332

EasyPact 100 TM trip units

15-16 A

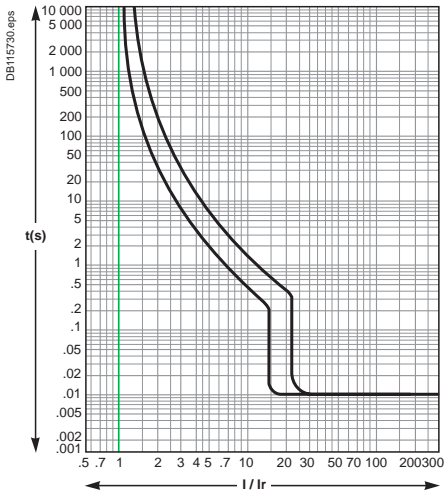

20 A

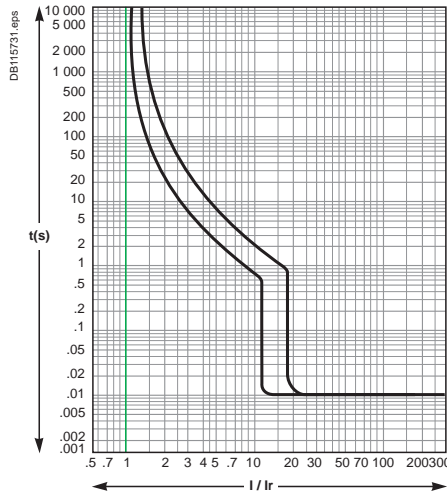

25 A

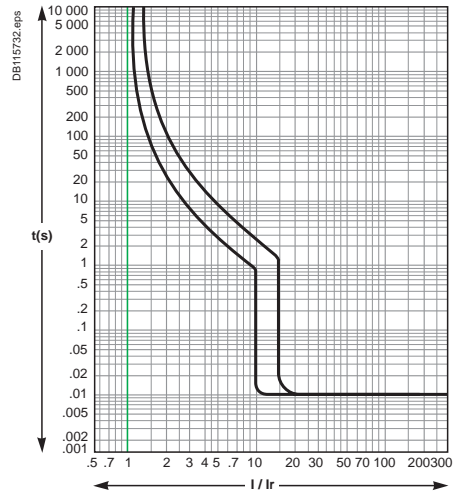

30-32 A

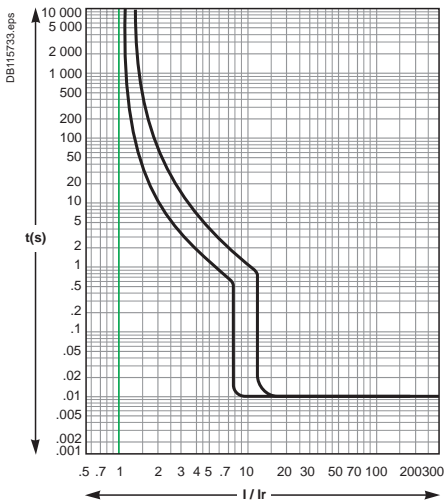

40 A

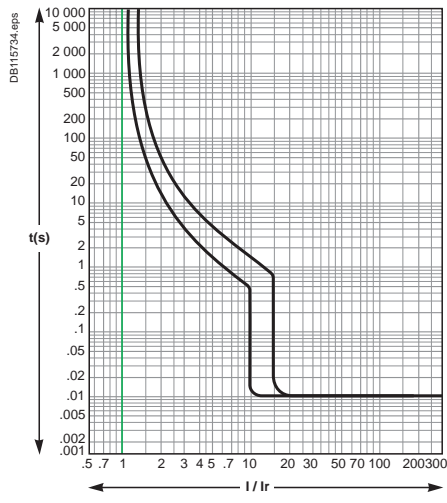

45-50 A

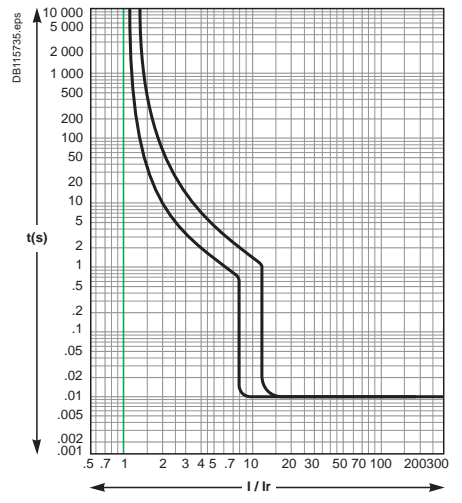

60-63 A

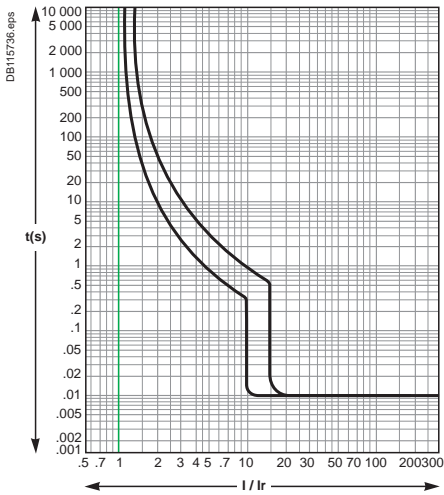

75 A

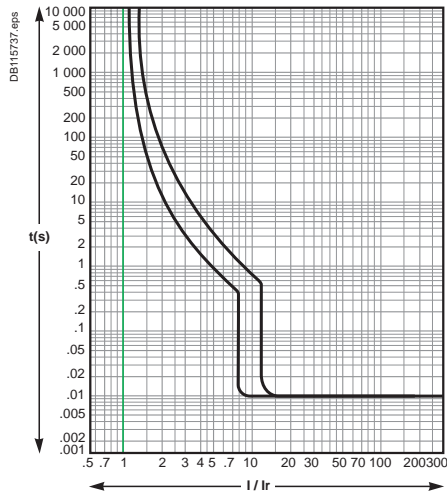

80 A

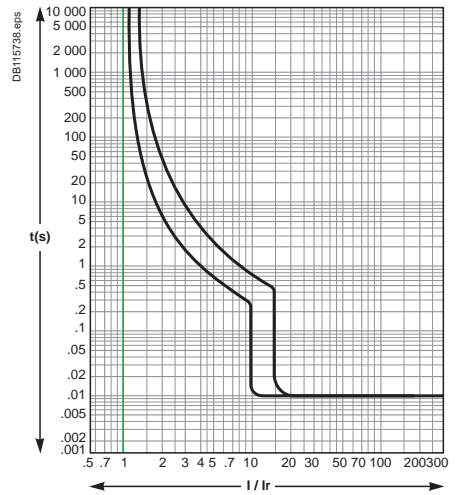

EasyPact 100 TM trip units (cont.)

100 A

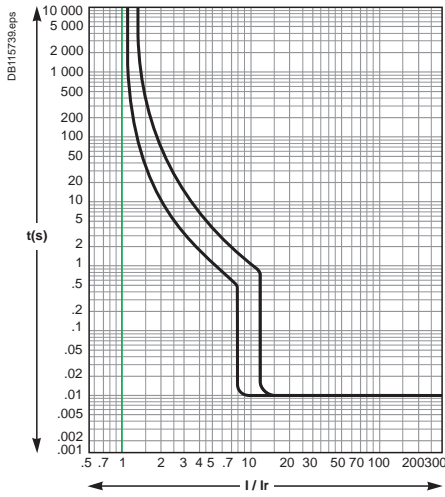

EasyPact 250 TM trip units

63-80-100-125 A

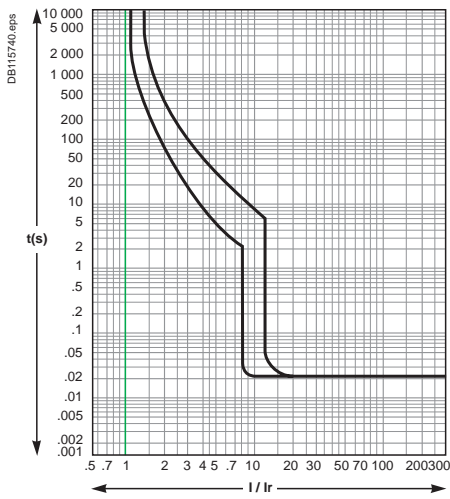

150-160-175-200 A

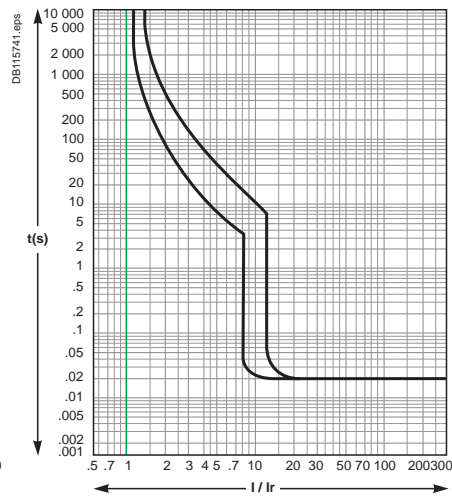

225-250 A

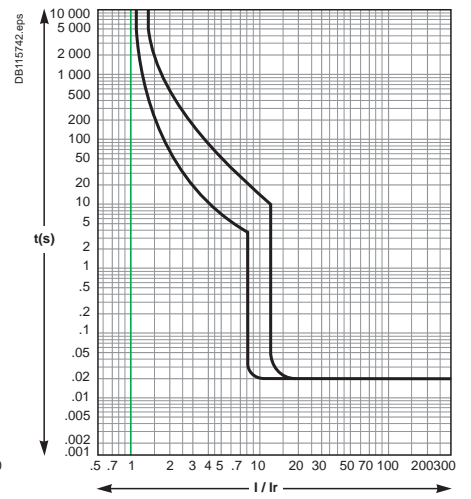

EasyPact 400 TM trip units

250-300-320-350-400 A

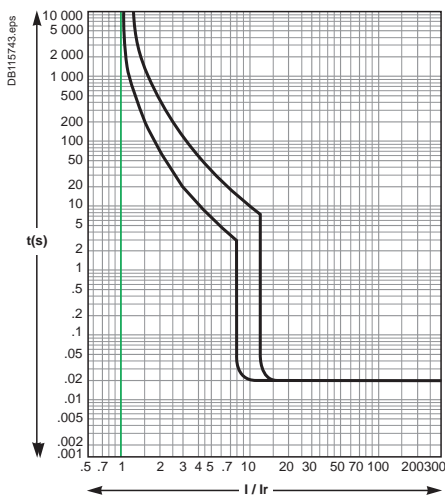

The limiting capacity of a circuit breaker is its aptitude to limit short-circuit currents.

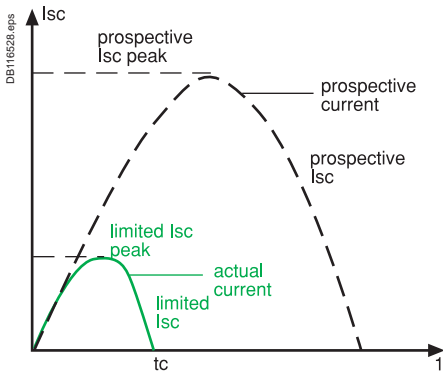

The exceptional limiting capacity of the EasyPact range greatly reduces the forces created by fault currents in devices. The result is a major increase in breaking performance.

The Ics value, defined by IEC standard 60947-2, is guaranteed by tests comprising the following operations:

- break three times consecutively a fault current equal from 25% to 100% of Icu
- check that the device continues to function normally:
 - it conducts the rated current without abnormal temperature rises
 - protection functions perform within the limits specified by the standard
 - suitability for isolation is not impaired.

Longer service life of electrical installations

Current-limiting circuit breakers greatly reduce the negative effects of short-circuits on installations.

Thermal effects

Less temperature rise in conductors, therefore longer service life for cables.

Mechanical effects

Reduced electrodynamic forces, therefore less risk of electrical contacts or busbars being deformed or broken.

Electromagnetic effects

Less disturbances for measuring devices located near electrical circuits.

Economy by means of cascading

Cascading is a technique directly derived from current limiting. Circuit breakers with breaking capacities less than the prospective short-circuit current may be installed downstream of a limiting circuit breaker. The breaking capacity is reinforced by the limiting capacity of the upstream device.

It follows that substantial savings can be made on downstream equipment and enclosures.

Current-limiting curves

The current-limiting capacity of a circuit breaker is expressed by two curves which are a function of the prospective short-circuit current (the current which would flow if no protection devices were installed):

- the actual peak current (limited current),
- thermal stress (A^2s), i.e. the energy dissipated by the short-circuit in a conductor with a resistance of 1Ω .

Current limiting curves 380/415 V AC

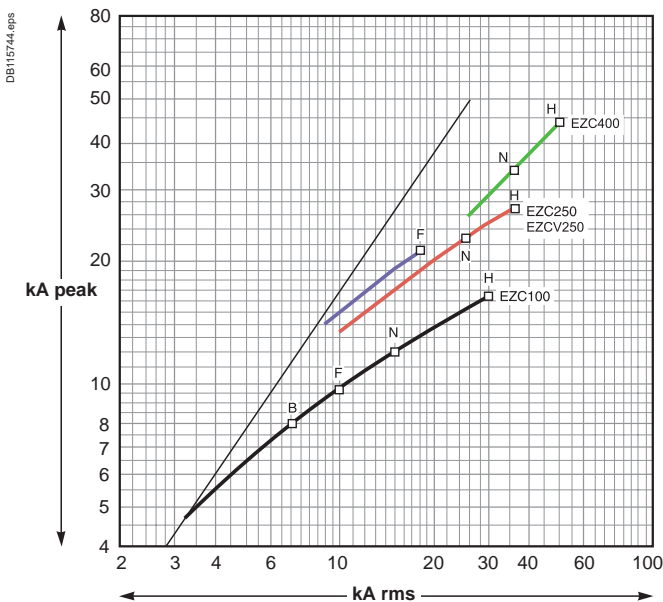

Thermal-stress curves 380/415 V AC

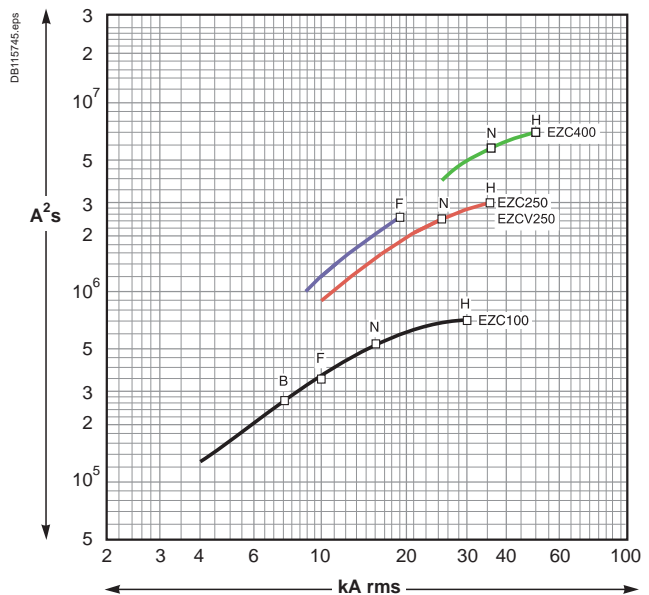

Cascading

What is cascading?

Cascading is the use of the current limiting capacity of circuit breakers at a given point to permit installation of lower-rated and therefore lower-cost circuit breakers downstream.

The upstream compact circuit breakers acts as a barrier against short-circuit currents. In this way, downstream circuit breakers with lower breaking capacities than the prospective short-circuit (at their point of installation) operate under their normal breaking conditions.

Since the current is limited throughout the circuit controlled by the limiting circuit breaker, cascading applies to all switchgear downstream. It is not restricted to two consecutive devices.

General use of cascading

With cascading, the devices can be installed in different switchboards. Thus, in general, cascading refers to any combination of circuit breakers where a circuit breaker with a breaking capacity less than the prospective I_{sc} at its point of installation can be used. Of course, the breaking capacity of the upstream circuit breaker must be greater than or equal to the prospective short-circuit current at its point of installation.

The combination of two circuit breakers in cascading configuration is covered by the IEC 60947-2.

Coordination between circuit breakers

The use of a protective device possessing a breaking capacity less than the prospective short-circuit current at its installation point is permitted as long as another device is installed upstream with at least the necessary breaking capacity. In this case, the characteristics of the two devices must be coordinated in such a way that the energy let through by the upstream device is not more than that which can be withstood by the downstream device and the cables protected by these devices without damage.

Cascading can only be checked by laboratory tests and the possible combinations can be specified only by the circuit breaker manufacturer.

220/240 V network downstream from a 380/415 V network

For 1P + N or 2P circuit breakers connected between the phase and neutral on a 380/415 V network, with a TT or TNS neutral system, consult the 220/240 V cascading table to determine cascading possibilities between upstream and downstream circuit breakers.

Economy by means of cascading

Thanks to cascading, circuit breakers with breaking capacities less than the prospective short-circuit current may be installed downstream from a current limiting circuit breaker.

It follows that substantial savings can be made on downstream switchgear and enclosures.

Cascading tables

Schneider Electric cascading tables are:

- drawn up on the basis of calculations (comparison between the energy limited by the upstream device and the maximum permissible thermal stress for the downstream device)
- verified experimentally in accordance with IEC standard 60947-2.

For distribution systems with 220/240 V, 380/415 V and 440 V between phases, the tables of the following pages indicate cascading possibilities between upstream Compact/EasyPact and downstream Multi 9 and EasyPact circuit breakers.

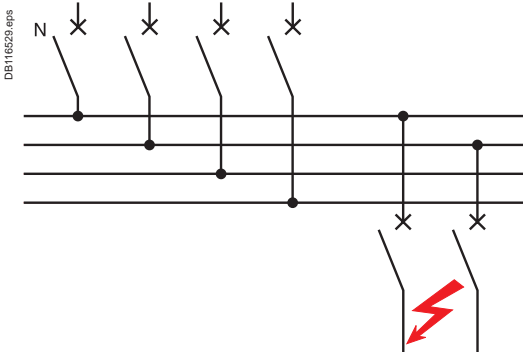

DE116529.eps

DB127584.eps

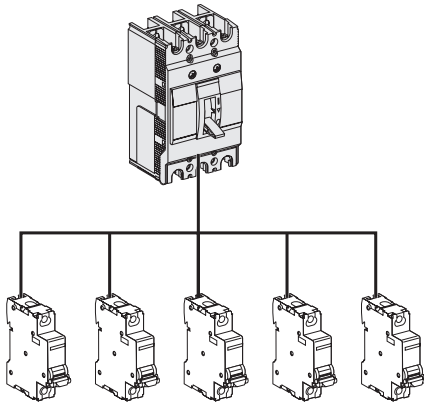

Network 220/240 V

Upstream		EZC100F	EZC100N	EZC100H
Breaking capacity kA rms		25	25	100
Downstream		Enhanced breaking capacity		
NC45	6	10	10	15
NC45N	10	15	15	25
NC45H	15	25	25	50
C60a	10	25	25	50
C60N	20	25	25	65
C60H	30	-	-	65
QO-E	10	25	25	50

Upstream		EZC250F	EZC250N EZCV250N	EZC250H EZCV250H	NS250H
Breaking capacity kA rms		25	50	85	100
Downstream		Enhanced breaking capacity			
EZC100B	10	-	-	15	20
EZC100F	25	-	30	30	50
EZC100N	25	-	30	36	50
EZC100H	100	-	-	-	-

Upstream		EZC400N	EZC400H	NB400 NB630	NS400N NS630N	NS400H NS630H
Breaking capacity kA rms		85	100	85	85	100
Downstream		Enhanced breaking capacity				
EZC100B	10	20	20	20	20	20
EZC100F	25	50	50	50	50	50
EZC100N	25	50	50	50	50	50
EZC100H	100	-	-	-	-	-
EZC250F	25	50	50	50	50	50
EZC/EZCV250N	50	85	85	85	85	85
EZC/EZCV250H	85	-	100	-	-	100

Network 380/415 V

Upstream		EZC100F	EZC100N	EZC100H
Breaking capacity kA rms		10	15	30
Downstream		Enhanced breaking capacity		
NC45	5	6	8	15
NC45N	8	10	10	15
NC45H	10	-	15	15
C60a	6	10	15	15
C60N	10	-	15	15
C60H	15	-	-	15
QO-E	5	10	15	15
GV2M	15	-	-	-

Upstream		EZC250F	EZC250N EZCV250N	EZC250H EZCV250H	NS250H
Breaking capacity kA rms		18	25	36	70
Downstream		Enhanced breaking capacity			
EZC100B	7.5	-	-	-	15
EZC100F	10	-	15	15	30
EZC100N	15	-	20	25	50
EZC100H	30	-	-	36	70

Upstream		EZC400N	EZC400H	NB400 NB630	NS400N NS630N	NS400H NS630H
Breaking capacity kA rms		36	50	30	50	70
Downstream		Enhanced breaking capacity				
EZC100B	7.5	-	-	-	-	-
EZC100F	10	-	-	-	-	-
EZC100N	15	20	20	20	20	30
EZC100H	30	36	36	-	45	50
EZC250F	18	20	20	20	20	20
EZC/EZCV250N	25	36	36	30	36	40
EZC/EZCV250H	36	-	-	-	45	50

DB127585.eps

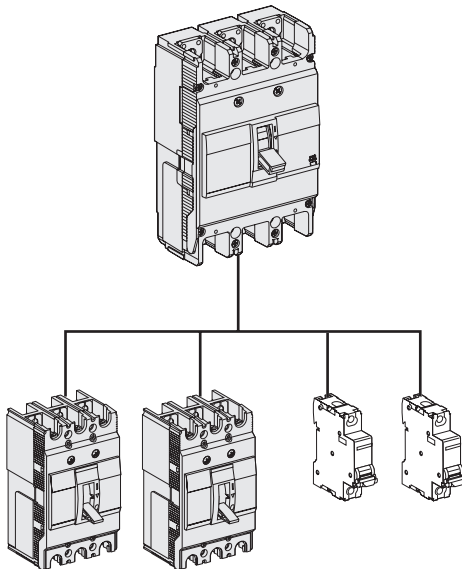

Network 440 V

Upstream		EZC250F	EZC250N EZCV250N	EZC250H EZCV250H
Breaking capacity kA rms		15	20	25
Downstream		Enhanced breaking capacity		
EZC100B	5	-	-	-
EZC100F	7.5	-	-	-
EZC100N	10	-	15	15
EZC100H	20	-	-	-

Upstream		EZC400N	EZC400H	NB400 NB630	NS400N NS630N	NS400H NS630H
Breaking capacity kA rms		20	40	30	42	65
Downstream		Enhanced breaking capacity				
EZC100B	5	-	-	-	-	-
EZC100F	7.5	-	-	-	-	-
EZC100N	10	15	15	15	15	25
EZC100H	25	-	30	30	30	30
EZC250F	15	20	20	-	-	-
EZC/EZCV250N	20	-	25	25	25	30
EZC/EZCV250H	25	-	30	30	30	30

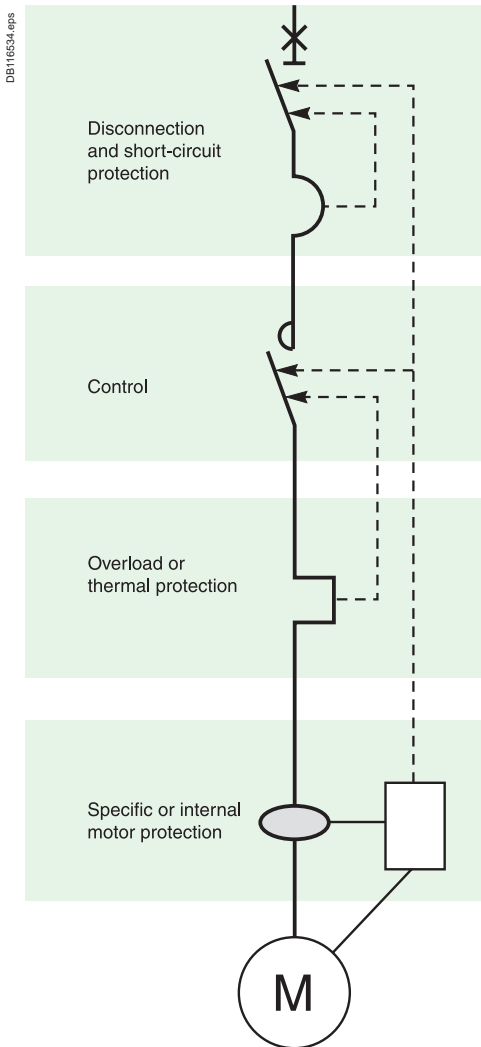
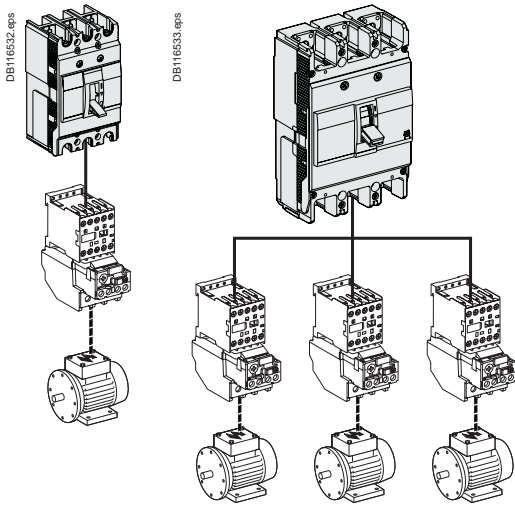

A circuit supplying a motor may include one, two, three or four switchgear or controlgear devices fulfilling one or more functions.

When a number of devices are used, they must be coordinated to ensure optimum operation of the motor.

Protection of a motor circuit involves a number of parameters that depend on:

- the application (type of machine driven, operating safety, starting frequency, etc.)
- the level of service continuity imposed by the load or the application
- the applicable standards to ensure protection of life and property.

The necessary electrical functions are of very different natures:

- short circuit protection
- overload protection dedicated for motor
- control (generally with high endurance levels)
- isolation.

Protection functions

Disconnection functions:

Isolate a motor circuit prior to maintenance operations.

Short-circuit protection:

Protect the starter and the cables against major overcurrents ($> 10 I_n$).

This type of protection is provided by a circuit breaker.

Control:

Start and stop the motor and, if applicable:

- gradual acceleration
- speed control.

Overload protection:

Protect the starter and the cables against minor overcurrents ($< 10 I_n$).

Thermal relays provide protection against this type of fault. They may be:

- integrated in the short-circuit protective device
- separate.

Additional specific protection:

- limitative fault protection (while the motor is running)
- preventive fault protection (monitoring of motor insulation with motor off).

Overloads ($I < 10 I_n$)

An overload may be caused by:

- an electrical problem, for instance on the mains (loss of a phase, voltage outside tolerances, etc.)
- a mechanical problem, for instance excessive torque due to abnormally high demands by the process or motor damage (bearing vibrations, etc.).

A further consequence of these two origins is excessively long starting.

Impedance short-circuit ($10 < I < 50 I_n$)

Deterioration of motor-winding insulation is the primary cause.

Short-circuit ($I > 50 I_n$)

This type of fault is relatively rare. A possible cause may be a connection error during maintenance.

Protection against insulation faults

This type of protection may be provided by:

- a residual current device (RCD)
- an insulation monitoring device (IMD).

Motors P (kW)	220/230 V		240 V		Circuit breakers		380/400 V		415 V		Circuit breakers		440 V		Circuit breakers	
	I (A)	I (A)	Type	Rating In (A)	Type	Rating In (A)	Type	Rating In (A)	Type	Rating In (A)	Type	Rating In (A)	Type	Rating In (A)	Type	Rating In (A)
0.37	2	1.8	EZC100	20			EZC100	20			EZC100	20			EZC100	20
0.55	2.8	2.6		20				1.6	1.5			20				20
0.75	3.5	3.2		20				2	1.8			20				20
1.1	5	4.5		20				2.8	2.6			20				20
1.5	6.5	6		20				3.7	3.4			20				20
2.2	9	8		20				5.3	4.8			20				20
3	12	11		20				7	6.5			20				20
4	15	14		20				9	8.2			20				20
5.5	21	19		40				12	11			20				20
7.5	28	25		60				16	14			20				20
10	36	33		60				21	19			40				40
11	39	36		80				23	21			40				40
15	52	48		80				30	28			60				60
18.5	63	59		80				37	34			60				60
22	75	70	EZC250	125				43	40			80				60
30	100	95		160				59	55	EZC250		125				80
37	125	115		250				72	66			150			EZC250	125
45	150	140		250				85	80			160				150
55	180	170	EZC400	300				105	100			200				160
75	250	235		-				140	135			250				250
90	300	270		-				170	160	EZC400		300				250
110	360	330		-				210	200			350			EZC400	300

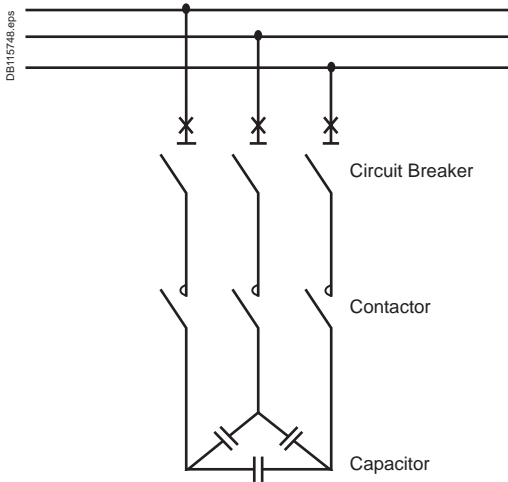

EasyPact circuit breaker is suitable for capacitor protection following the rules below:

■ **Inc = Nominal current of the capacitor**

$$I_{nc} = \frac{Q_c}{U \sqrt{3}}$$

Inc = Nominal Current Capacitor (A)
 Qc = Reactive power (kVAR)
 U = Nominal Voltage (V)

■ **Inb = Nominal current of the circuit breaker (EZC)**

- Inb = 1.36 x Inc for standard equipment
- Inb = 1.5 x Inc for overrated type equipment
- Inb = 1.12 x Inc for detuned type equipment: 2.7 tuning
- Inb = 1.19 x Inc for detuned type equipment: 3.8 tuning
- Inb = 1.31 x Inc for detuned type equipment: 4.3 tuning
- the short-circuit (magnetic) protection-setting thresholds must enable passage of the energising transients: 10 x Inc for standard, overrated and detuned type equipment.

■ **Icu = Ultimate breaking capacity of the circuit breaker (EZC)**

Icu short-circuit level is given by the installation.

Example:

Table at 400 V AC - 3 phases 50 Hz for standard equipment.

Reactive power (kVAR)	Inc (A)	Inb (A)	Breaking capacity to Circuit Breaker	
			15 kA	30 kA
7.5	11	15	EZC100N3015	EZC100H3015
10	14	20	EZC100N3020	EZC100H3020
15	22	30	EZC100N3030	EZC100H3030
20	29	40	EZC100N3040	EZC100H3040
30	43	60	EZC100N3060	EZC100H3060
40	58	80	EZC100N3080	EZC100H3080
50	72	100	EZC100N3100	EZC100H3100
60	87	118	EZC250F3125	EZC250H3125
75	108	147	EZC250F3150	EZC250H3150
100	144	196	EZC250F3200	EZC250H3200

<i>Presentation</i>	//
<i>Functions and characteristics</i>	A-1
<i>Busbars</i>	B-1
<i>Installation guide</i>	C-1
EZC100N/H 1P/2P	
Circuit breaker	D-2
EZC100B/F/N/H 3P	
Circuit breaker	D-3
EZC100N/H 4P	
Circuit breaker	D-4
Accessories	D-5
EZC250F/N/H 2P/3P	
Circuit breaker	D-7
EZC250N/H 4P	
Circuit breaker	D-8
EZCV250N/H 3P/4P	
Earth-leakage circuit breaker	D-9
EZC250F/N/H, EZCV250N/H	
Accessories	D-10
EZC400N/H 3P/4P	
Circuit breaker	D-12
EZC400N/H	
Accessories	D-13
EasyPact Busbar	
Type-tested solution IEC 60439	3 rd cover

EZC100N/H 1P/2P

Circuit breaker

EasyPact EZC100N 1P 18 kA 220/240 V

With thermal magnetic trip unit

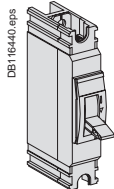

Rating	1P 1t
15 A	EZC100N1015
16 A	EZC100N1016
20 A	EZC100N1020
25 A	EZC100N1025
30 A	EZC100N1030
32 A	EZC100N1032
40 A	EZC100N1040
45 A	EZC100N1045
50 A	EZC100N1050
60 A	EZC100N1060
63 A	EZC100N1063
75 A	EZC100N1075
80 A	EZC100N1080
100 A	EZC100N1100

EasyPact EZC100H 1P 25 kA - 2P 50 kA 220/240 V

With thermal magnetic trip unit

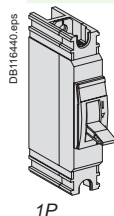

1P

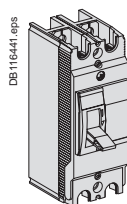

2P

Rating	1P 1t	2P 2t
15 A	EZC100H1015	EZC100H2015
16 A	EZC100H1016	EZC100H2016
20 A	EZC100H1020	EZC100H2020
25 A	EZC100H1025	EZC100H2025
30 A	EZC100H1030	EZC100H2030
32 A	EZC100H1032	EZC100H2032
40 A	EZC100H1040	EZC100H2040
45 A	EZC100H1045	EZC100H2045
50 A	EZC100H1050	EZC100H2050
60 A	EZC100H1060	EZC100H2060
63 A	EZC100H1063	EZC100H2063
75 A	EZC100H1075	EZC100H2075
80 A	EZC100H1080	EZC100H2080
100 A	EZC100H1100	EZC100H2100

EZC100B/F/N/H 3P

Circuit breaker

EasyPact EZC100B 3P 7.5 kA 400/415 V

With thermal magnetic trip unit

DB116442.eps

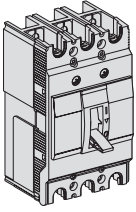

Rating	3P 3t
15 A	EZC100B3015
16 A	EZC100B3016
20 A	EZC100B3020
25 A	EZC100B3025
30 A	EZC100B3030
32 A	EZC100B3032
40 A	EZC100B3040
45 A	EZC100B3045
50 A	EZC100B3050
60 A	EZC100B3060

EasyPact EZC100F 3P 10 kA 400/415 V

With thermal magnetic trip unit

DB116442.eps

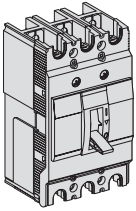

Rating	3P 3t
15 A	EZC100F3015
16 A	EZC100F3016
20 A	EZC100F3020
25 A	EZC100F3025
30 A	EZC100F3030
32 A	EZC100F3032
40 A	EZC100F3040
45 A	EZC100F3045
50 A	EZC100F3050
60 A	EZC100F3060
63 A	EZC100F3063
75 A	EZC100F3075
80 A	EZC100F3080
100 A	EZC100F3100

EasyPact EZC100N 3P 15 kA 400/415 V

With thermal magnetic trip unit

DB116442.eps

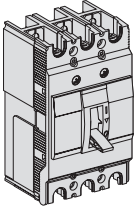

Rating	3P 3t
15 A	EZC100N3015
16 A	EZC100N3016
20 A	EZC100N3020
25 A	EZC100N3025
30 A	EZC100N3030
32 A	EZC100N3032
40 A	EZC100N3040
45 A	EZC100N3045
50 A	EZC100N3050
60 A	EZC100N3060
63 A	EZC100N3063
75 A	EZC100N3075
80 A	EZC100N3080
100 A	EZC100N3100

EasyPact EZC100H 3P 30 kA 400/415 V

With thermal magnetic trip unit

DB116442.eps

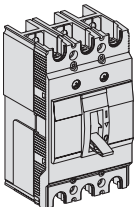

Rating	3P 3t
15 A	EZC100H3015
16 A	EZC100H3016
20 A	EZC100H3020
25 A	EZC100H3025
30 A	EZC100H3030
32 A	EZC100H3032
40 A	EZC100H3040
45 A	EZC100H3045
50 A	EZC100H3050
60 A	EZC100H3060
63 A	EZC100H3063
75 A	EZC100H3075
80 A	EZC100H3080
100 A	EZC100H3100

EZC100N/H 4P

Circuit breaker

EasyPact EZC100N 4P 15 kA 400/415 V

With thermal magnetic trip unit

DB114620 eps

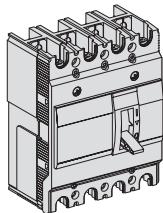

Rating	4P 3t
15 A	EZC100N4015
16 A	EZC100N4016
20 A	EZC100N4020
25 A	EZC100N4025
30 A	EZC100N4030
32 A	EZC100N4032
40 A	EZC100N4040
45 A	EZC100N4045
50 A	EZC100N4050
60 A	EZC100N4060
63 A	EZC100N4063
75 A	EZC100N4075
80 A	EZC100N4080
100 A	EZC100N4100

EasyPact EZC100H 4P 30 kA 400/415 V

With thermal magnetic trip unit

DB114620 eps

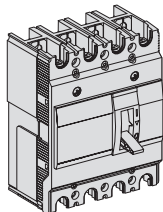



Rating	4P 3t
15 A	EZC100H4015
16 A	EZC100H4016
20 A	EZC100H4020
25 A	EZC100H4025
30 A	EZC100H4030
32 A	EZC100H4032
40 A	EZC100H4040
45 A	EZC100H4045
50 A	EZC100H4050
60 A	EZC100H4060
63 A	EZC100H4063
75 A	EZC100H4075
80 A	EZC100H4080
100 A	EZC100H4100

EZC100N/H/B/F

Accessories

Connection accessories

Cable lugs

DB100821.eps 	≤ 50 A	Cables from 2.5 to 16 mm ²	Set of 2	EZALUG0502
			Set of 3	EZALUG0503
DB100822.eps 	> 50 A	Cables from 10 to 50 mm ²	Set of 2	EZALUG1002
			Set of 3	EZALUG1003

Spreaders

DB11674.eps 	Spreaders for 3P breaker		Set of 3	EZASPDR3P
	Spreaders for 4P breaker		Set of 4	EZASPDR4P

Terminal shields

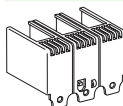
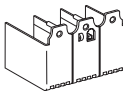
DB100824.eps 	Terminal shields for 3P breaker		Set of 2	EZATSHD3P
	Terminal shields for 4P breaker		Set of 2	EZATSHD4P
				

Sealing screws

DB100825.eps 	Sealing screws		Set of 2	EZASSCR
---	----------------	--	----------	---------

Phase barriers

DB100826.eps 	Phase barriers		Set of 2	EZAFASB2
---	----------------	--	----------	----------

Electrical auxiliaries

Indication contacts

DB11665.eps 	Auxiliary switch (AX)			EZAUX10
DB11663.eps 	Alarm switch (AL)			EZAUX01
DB11669.eps 	Auxiliary switch + alarm switch (AX + AL)			EZAUX11

Electrical auxiliaries (cont.)

Voltage releases

Ds100830.eps

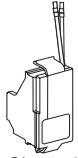

Shunt trip (SHT)

	Voltage	MX/SHT
AC	100-130 V	EZASHT100AC
	200-277 V	EZASHT200AC
	380-480 V	EZASHT380AC
DC	24 V	EZASHT024DC
	48 V	EZASHT048DC

Ds100831.eps

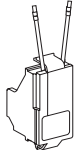

Under voltage release (UVR)

	Voltage	MN/UVR
AC	110-130 V	EZAUVR110AC
	200-240 V	EZAUVR200AC
	277 V	EZAUVR277AC
	380-415 V	EZAUVR380AC
	440-480 V	EZAUVR440AC
DC	24 V	EZAUVR024DC
	48 V	EZAUVR048DC
	125 V	EZAUVR125DC

Rotary handles

Direct rotary handle (for 3/4P breaker)

Ds100832.eps



Direct rotary handle (black)	EZAROTDS
Direct rotary handle (red/yellow)	EZAROTDSRY

Extended rotary handle (for 3/4P breaker)

Ds100833.eps

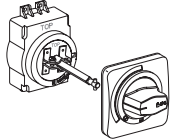

Extended rotary handle (black)	EZAROTE
Extended rotary handle (red/yellow)	EZAROTERY

Locks

Padlocking system

Ds100834.eps



Padlocking system	EZALOCK
-------------------	---------

Installation accessory

DIN rail adaptor

Ds100835.eps

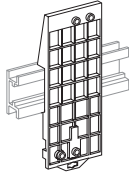

For 2 x 1P or 1 x 2P or 1 x 3P breaker	EZADINR
Note: for 4P breaker, use 2 adaptors	

Plug-in

Plug-in 100 A

Ds17502.eps

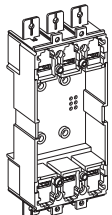

Kit, plug-in base 3P 15 A-50 A	EZAPLUG3L
Kit, plug-in base 3P 60 A-100 A	EZAPLUG3H
Fishbone connectors set of 3	EZAFSHB3
Plug-in connectors 15 A-50 A set of 2	EZAPCON1L
Plug-in connectors 60 A-100 A set of 2	EZAPCON1H

EZC250F/N/H 2P/3P

Circuit breaker

EasyPact EZC250F 3P 18 kA 400/415 V

With thermal magnetic trip unit

DB111751.jpg

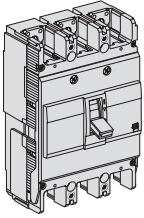

Rating	3P 3t
100 A	EZC250F3100
125 A	EZC250F3125
150 A	EZC250F3150
160 A	EZC250F3160
175 A	EZC250F3175
200 A	EZC250F3200
225 A	EZC250F3225
250 A	EZC250F3250

EasyPact EZC250N 3P 25 kA 400/415 V

With thermal magnetic trip unit

DB111751.jpg

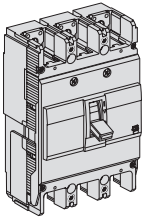

Rating	3P 3t
100 A	EZC250N3100
125 A	EZC250N3125
150 A	EZC250N3150
160 A	EZC250N3160
175 A	EZC250N3175
200 A	EZC250N3200
225 A	EZC250N3225
250 A	EZC250N3250

EasyPact EZC250H 2/3P 36 kA 400/415 V

With thermal magnetic trip unit

DB111751.jpg

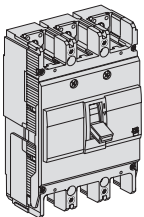

Rating	2P 2t	3P 3t
100 A	EZC250H2100	EZC250H3100
125 A	EZC250H2125	EZC250H3125
150 A	EZC250H2150	EZC250H3150
160 A	EZC250H2160	EZC250H3160
175 A	EZC250H2175	EZC250H3175
200 A	EZC250H2200	EZC250H3200
225 A	EZC250H2225	EZC250H3225
250 A	EZC250H2250	EZC250H3250

EZC250N/H 4P

Circuit breaker

EasyPact EZC250N 4P 25 kA 400/415 V

With thermal magnetic trip unit

DB111686.eps

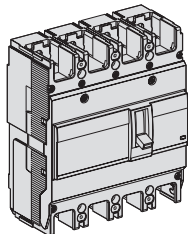

Rating	4P 3t	4P 4t
63 A	EZC250N4063	EZC250N44063
80 A	EZC250N4080	EZC250N44080
100 A	EZC250N4100	EZC250N44100
125 A	EZC250N4125	EZC250N44125
150 A	EZC250N4150	EZC250N44150
160 A	EZC250N4160	EZC250N44160
175 A	EZC250N4175	EZC250N44175
200 A	EZC250N4200	EZC250N44200
225 A	EZC250N4225	EZC250N44225
250 A	EZC250N4250	EZC250N44250

EasyPact EZC250H 4P 36 kA 400/415 V

With thermal magnetic trip unit

DB111686.eps

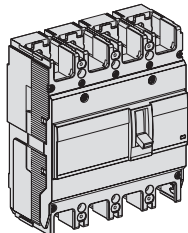

Rating	4P 3t	4P 4t
63 A	EZC250H4063	EZC250H44063
80 A	EZC250H4080	EZC250H44080
100 A	EZC250H4100	EZC250H44100
125 A	EZC250H4125	EZC250H44125
150 A	EZC250H4150	EZC250H44150
160 A	EZC250H4160	EZC250H44160
175 A	EZC250H4175	EZC250H44175
200 A	EZC250H4200	EZC250H44200
225 A	EZC250H4225	EZC250H44225
250 A	EZC250H4250	EZC250H44250

EZCV250N/H 3P/4P

Earth-leakage circuit breaker

EasyPact EZCV250N 3P 25 kA 400/415 V

With thermal magnetic trip unit and earth leakage protection

DB111504.eps

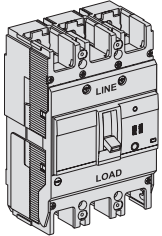

Rating	3P 3t
63 A	EZCV250N3063
80 A	EZCV250N3080
100 A	EZCV250N3100
125 A	EZCV250N3125
150 A	EZCV250N3150
160 A	EZCV250N3160
175 A	EZCV250N3175
200 A	EZCV250N3200
225 A	EZCV250N3225
250 A	EZCV250N3250

EasyPact EZCV250H 3P 36 kA 400/415 V

With thermal magnetic trip unit and earth leakage protection

DB111504.eps

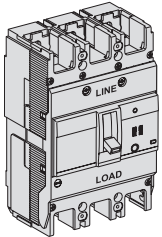

Rating	3P 3t
63 A	EZCV250H3063
80 A	EZCV250H3080
100 A	EZCV250H3100
125 A	EZCV250H3125
150 A	EZCV250H3150
160 A	EZCV250H3160
175 A	EZCV250H3175
200 A	EZCV250H3200
225 A	EZCV250H3225
250 A	EZCV250H3250

EasyPact EZCV250N 4P 25 kA 400/415 V

With thermal magnetic trip unit and earth leakage protection

DB111505.eps

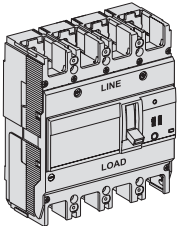

Rating	4P 3t	4P 4t
63 A	EZCV250N4063	EZCV250N44063
80 A	EZCV250N4080	EZCV250N44080
100 A	EZCV250N4100	EZCV250N44100
125 A	EZCV250N4125	EZCV250N44125
150 A	EZCV250N4150	EZCV250N44150
160 A	EZCV250N4160	EZCV250N44160
175 A	EZCV250N4175	EZCV250N44175
200 A	EZCV250N4200	EZCV250N44200
225 A	EZCV250N4225	EZCV250N44225
250 A	EZCV250N4250	-

EasyPact EZCV250H 4P 36 kA 400/415 V

With thermal magnetic trip unit and earth leakage protection

DB111505.eps

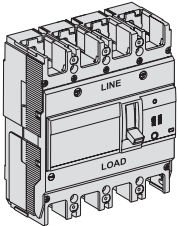

Rating	4P 3t	4P 4t
63 A	EZCV250H4063	EZCV250H44063
80 A	EZCV250H4080	EZCV250H44080
100 A	EZCV250H4100	EZCV250H44100
125 A	EZCV250H4125	EZCV250H44125
150 A	EZCV250H4150	EZCV250H44150
160 A	EZCV250H4160	EZCV250H44160
175 A	EZCV250H4175	EZCV250H44175
200 A	EZCV250H4200	EZCV250H44200
225 A	EZCV250H4225	EZCV250H44225
250 A	EZCV250H4250	-

Connection accessories

Cable lugs

 DB10209.eps	250 A	Cables from 42 to 152 mm ²	Set of 3	EZELUG2503
			Set of 4	EZELUG2504

Terminal extensions

 DB11752.eps	Terminal extension for 3P breaker		Set of 3	EZETEX
	Terminal extension for 4P breaker		Set of 4	EZETEX4P

Spreaders

 DB11674.eps	Spreaders for 3P breaker		Set of 3	EZESPDR3P
	Spreaders for 4P breaker		Set of 4	EZESPDR4P

Terminal shields





 DB105210.eps	Terminal shields for 3P breaker (60 mm depth)		Set of 2	EZETSHD3P
	Terminal shields for 3P breaker (68 mm depth)		Set of 2	EZETSHD3PN
	Terminal shields for 4P breaker (68 mm depth)		Set of 2	EZETSHD4PN

Phase barriers

 DB105211.eps	Phase barriers for 60 mm depth		Set of 2	EZEFASB2
	Phase barriers for 68 mm depth		Set of 3	EZEFASB3N

Electrical auxiliaries

Indication contacts

 DB10212.eps	Auxiliary switch (AX)			EZEAX
 DB105213.eps	Alarm switch (AL)			EZEAL
 DB105214.eps	Auxiliary switch + alarm switch (AX + AL)			EZEAXAL
 DB11687.eps	Earth-leakage alarm switch (ALV) (only for EZCV250)			EZEALV

Electrical auxiliaries (cont.)

Voltage releases

DB105215.eps

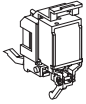

Shunt trip (SHT)

	Voltage	MX/SHT
AC	100-120 V	EZESHT100AC
	120-130 V	EZESHT120AC
	200-240 V	EZESHT200AC
	277 V	EZESHT277AC
	380-440 V	EZESHT400AC
DC	440-480 V	EZESHT440AC
	24 V	EZESHT024DC
	48 V	EZESHT048DC

DB11506.eps

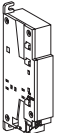

(UVR)

DB11632.eps



(UVRN)

Under voltage release

	Voltage	MN/UVR	MN/UVR ⁽¹⁾
AC	110-130 V	EZEUVR110AC	EZEUVRN110AC
	200-240 V	EZEUVR200AC	EZEUVRN200AC
	277 V	EZEUVR277AC	EZEUVRN277AC
	380-415 V	EZEUVR400AC	EZEUVRN400AC
	440-480 V	EZEUVR440AC	EZEUVRN440AC
DC	24 V	EZEUVR024DC	EZEUVRN024DC
	48 V	EZEUVR048DC	EZEUVRN048DC
	125 V	EZEUVR125DC	EZEUVRN125DC

(1) Only EZC250-4P and EZCV250-3/4P

Rotary handles

Direct rotary handle

DB105216.eps

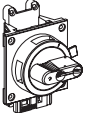

Direct rotary handle (black)	EZEROTDS
Direct rotary handle (red/yellow)	EZEROTDSRY

Extended rotary handle

DB105217.eps

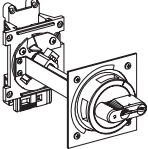

Extended rotary handle (black)	EZEROTE
Extended rotary handle (red/yellow)	EZEROTERY

Locks

Padlocking system

DB105218.eps



Padlocking system for EZC250-3P	EZELOCK
Padlocking system for EZC250-4P and EZCV250-3/4P	EZELOCKN

Plug-in

Plug-in 250 A

DB127593.eps

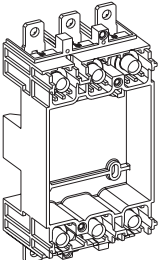

Kit, plug-in base 3P 100 A-250 A 60 mm breaker	EZEPLUG3L
Kit, plug-in base 3P 100 A-250 A 68 mm breaker	EZEPLUG3H
Kit, plug-in base 4P 100 A-250 A 68 mm breaker	EZEPLUG4
Kit, plug-in connectors 100 A-250 A set of 2	EZEPCON1

EZC400N/H 3P/4P

Circuit breaker

EasyPact EZC400N 3P 36 kA 400/415 V

With thermal magnetic trip unit

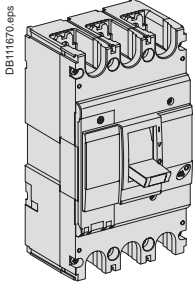

Rating	3P 3t
250 A	EZC400N3250
300 A	EZC400N3300
320 A	EZC400N3320
350 A	EZC400N3350
400 A	EZC400N3400

EasyPact EZC400H 3P 50 kA 400/415 V

With thermal magnetic trip unit

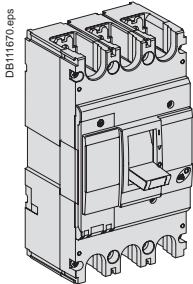

Rating	3P 3t
250 A	EZC400H3250
300 A	EZC400H3300
320 A	EZC400H3320
350 A	EZC400H3350
400 A	EZC400H3400

EasyPact EZC400N 4P 36 kA 400/415 V

With thermal magnetic trip unit

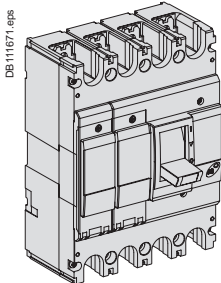

Rating	4P 3t	4P 4t
250 A	EZC400N4250	EZC400N44250
300 A	EZC400N4300	EZC400N44300
320 A	EZC400N4320	EZC400N44320
350 A	EZC400N4350	EZC400N44350
400 A	EZC400N4400	EZC400N44400

EasyPact EZC400H 4P 50 kA 400/415 V

With thermal magnetic trip unit

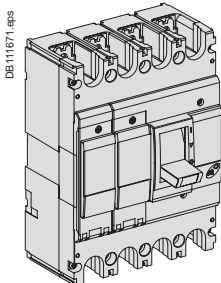

Rating	4P 3t	4P 4t
250 A	EZC400H4250	EZC400H44250
300 A	EZC400H4300	EZC400H44300
320 A	EZC400H4320	EZC400H44320
350 A	EZC400H4350	EZC400H44350
400 A	EZC400H4400	EZC400H44400

EZC400N/H

Accessories

Connection accessories

Cable lugs

 DB111673.eps	400 A	Cables from 35 to 300 mm ²	Set of 3	EZ4LUG4003
			Set of 4	EZ4LUG4004

Spreaders

 DB111672.eps	Spreaders 70 mm	For 3P breaker	Set of 3	EZ4SPDR73P
		For 4P breaker	Set of 4	EZ4SPDR74P

Terminal shields

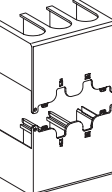
 DB111635.eps	Terminal shields for 3P breaker		Set of 2	EZ4TSHD3P
	Terminal shields for 4P breaker		Set of 2	EZ4TSHD4P

Phase barriers



 DB111636.eps	Phase barriers for 3P breaker		Set of 2	EZ4FASB2
	Phase barriers for 4P breaker		Set of 3	EZ4FASB3

Electrical auxiliaries

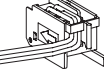
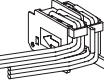
Indication contacts

 DB111638.eps	Signalling switch (auxiliary switch AX or alarm switch AL)			EZ4AUX
 DB111637.eps	Double signalling switch (2 AX or 2 AL)			EZ4AUX2

Voltage releases

		Voltage	MX/SHT
 DB111639.eps Shunt trip (SHT)	AC	24-48 V	EZ4SHT048ACDC
		100-240 V	EZ4SHT200ACDC
		277 V	EZ4SHT277AC
		380-480 V	EZ4SHT400AC
DC	24-48 V	EZ4SHT048ACDC	
	100-220 V	EZ4SHT200ACDC	
 DB111639.eps Under voltage release (UVR)	AC	24 V	EZ4UVR024ACDC
		48 V	EZ4UVR048ACDC
		100-110 V	EZ4UVR110ACDC
		120-130 V	EZ4UVR130ACDC
		200-240 V	EZ4UVR200AC
		277 V	EZ4UVR277AC
	DC	380-480 V	EZ4UVR400AC
		24 V	EZ4UVR024ACDC
		48 V	EZ4UVR048ACDC
		125 V	EZ4UVR130ACDC

Rotary handles

Direct rotary handle

DB111640.eps



Direct rotary handle

EZ4ROTDS

Extended rotary handle

DB111641.eps

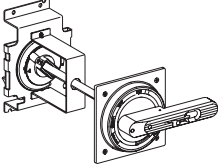

Extended rotary handle

EZ4ROTE

Locks

Padlocking system

DB111642.eps



Padlocking system

EZ4LOCK

EasyPact Busbar

Type-tested solution IEC 60439

Main Busbar

Main Busbar (EasyPact 100/3P)

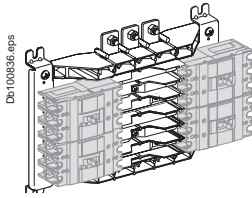

4 ways (3P)

	250 A	400 A	630 A
4 ways	EZB250W04	EZB400W04	EZB630W04
6 ways	EZB250W06	EZB400W06	EZB630W06
8 ways	EZB250W08	EZB400W08	EZB630W08
10 ways	EZB250W10	EZB400W10	EZB630W10
12 ways	EZB250W12	EZB400W12	EZB630W12

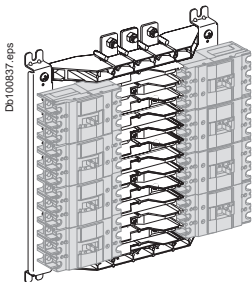

8 ways (3P)

Branch extension (EasyPact/Compact NS/NB)

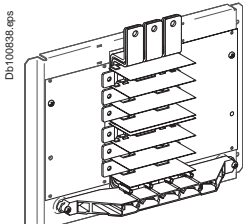

4 ways (3P)

2 ways	EZBNS2
4 ways	EZBNS4

Main incoming connections (EasyPact/Compact NS/NB)

Main connectors

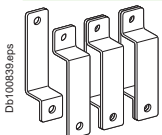

	250 A	400 A	630 A
Main connectors	EZB250MCNS	EZB400MCNS	EZB630MCNS
To connect the main in-comer to EasyPact busbar (EasyPact/Compact NS/NB or INS switch)			

Mechanical lugs

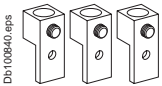

	250 A	400 A	630 A
Incoming cable size	16-150 mm ²	35-300 mm ²	25-240 mm ² 2 cables per phase
Lug kit for bare incoming cables	EZB250MLUG	EZB400MLUG	EZB630MLUG

Connector caps

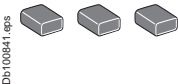

Connector caps for 100 A out goings	Set of 3	EZB100CAP
Connector caps for 250 A out goings	Set of 3	EZB250CAP
To isolate connections when branch breaker not installed		

Schneider Electric Industries SAS

35, rue Joseph Monier
CS 30323
92506 Rueil Malmaison Cedex
France

RCS Nanterre 954 503 439
Capital social 896 313 776 €
www.schneider-electric.com

LVPED208003EN

As standards, specifications and designs change from time to time, please ask for confirmation of the information given in this publication.



This document has been printed on ecological paper

Design: Schneider Electric
Photos: Schneider Electric
Edition: Altavia Connexion - made in France



ART.960252 © 2011 - Schneider Electric - All rights reserved.

04-2011