

Kumanda Butonlari

Push Buttons

EMAS®



Kumanda Butonları

Push Buttons

B Serisi (IP50)

| | |
|--|------|
| Genel Özellikler ve Teknik Bilgiler | A-2 |
| Genel Şema | A-3 |
| B Serisi Kumanda Butonları Seçim Tablosu | A-4 |
| B Serisi Ø22 mm Adaptörlü Kumanda Butonu Tipleri | A-5 |
| B Serisi Kontak Bloklar ve Işık Blokları | A-9 |
| Aksesuarlar | A-10 |
| Montaj Şekli ve Boyutlar | A-11 |

C Serisi (IP65)

CP Plastik Serisi

| | |
|-------------------------------------|------|
| Genel Özellikler ve Teknik Bilgiler | A-12 |
| Genel Şema | A-13 |

CM Metal Serisi

| | |
|--|------|
| Genel Özellikler ve Teknik Bilgiler | A-14 |
| Genel Şema | A-15 |
| C Serisi Kumanda Butonları Seçim Tablosu | A-16 |
| C Serisi Ø22 mm Adaptörlü Kumanda Butonu Tipleri | A-17 |
| C Serisi Kontak Bloklar ve Işık Blokları | A-20 |
| Aksesuarlar | A-21 |
| Montaj Şekli ve Boyutlar | A-22 |

MB Serisi (IP40)

| | |
|-------------------------------------|------|
| Genel Özellikler ve Teknik Bilgiler | A-24 |
| Seçim Tablosu ve Aksesuarlar | A-25 |

B Series (IP50)

| | |
|--|------|
| General Specifications and Technical Information | A-2 |
| General Scheme | A-3 |
| B Series Push Buttons Selection Table | A-4 |
| B Series Ø22 mm Push Buttons With Adapter | A-5 |
| B Series Contact Blocks and Illumination Blocks | A-9 |
| Accessories | A-10 |
| Assembly and Dimensions | A-11 |

C Series (IP65)

CP Plastic Series

| | |
|--|------|
| General Specifications and Technical Information | A-12 |
| General Scheme | A-13 |

CM Metal Series

| | |
|--|------|
| General Specifications and Technical Information | A-14 |
| General Scheme | A-15 |
| C Series Push Buttons Selection Table | A-16 |
| C Series Ø22 mm Push Buttons With Adapter | A-17 |
| C Series Contact Blocks and Illumination Blocks | A-20 |
| Accessories | A-21 |
| Assembly and Dimensions | A-22 |

MB Series (IP40)

| | |
|--|------|
| General Specifications and Technical Information | A-24 |
| Selection Table & Accessories | A-25 |



B Serisi Ø 22 mm Adaptörlü Kumanda Butonları

- İşlevsel özellikleri artırılmış ve montajı kolaylaştırılmış gövde
- Lego mantığı ile ardarda eklenebilen gövde ve kontak bloklar.
- Darbelere dayanıklı polikarbonat basma düğmesi
- Can güvenliği açısından korumalı kablo giriş uçları.
- Korumalı LED'ler ile minimum ısınma, maksimum ömür.
- Rozet ve etiket çeşitleri ile konumlandırma imkanı.
- Tüm uygulamalara cevap verecek ürün çeşitliliği.
- İnsan hayatına değer veren (V0) PA6 gövde ile kontak blokların güvenilirliği
- Işıklı blok eklenerek durum takip kolaylığı.

Teknik Bilgiler

| | |
|--------------------------------|--|
| Mekanik Ömür | : 500.000 açma-kapama min. |
| Elektriksel Ömür | : 100.000 açma-kapama min. |
| Çalışma Sıcaklığı | : min./maks. °C -5/+40 |
| Koruma Sınıfı | : IP20 = Kontak blok için, IP50 = Ürün; pano veya kutuda ise |
| Çalışma Sıklığı | : Yüksüz 3000 açma-kapama/saat Yükte 1200 açma-kapama/saat |
| Anma İşletme Gerilimi Ue | : 250 V AC |
| Anma İşletme Akımı Ie | : 4 A |
| Anma Kesme Kapasitesi AC 15 | : 1000 VA 1 kA |
| Yalıtım Gerilimi Ui | : 300 V |
| Darbe Dayanım Gerilimi Uimp | : 2.5 kV |
| Standart Kontak Malzemesi | : AgNi |
| İzolasyon Direnci | : 10 MΩ min. (500 V DC) |
| Dielektrik Mukavemeti | : Gövde-Kontak arası 2000 V AC Açık Kontak 1500 V AC |
| Bağlantı Kablo Kesiti Standart | : 1.5-2.5 mm ² : UL 508 TS EN 60947-5-1 VDE0660 : IEC 60393-1 (BPR Potansiyometre için) |



B Series Ø22 mm Push Buttons With Adapter

- Functional specifications are maximized and assembly of the body facilitated.
- Sequential connectable body and contact blocks after lego logic.
- Contact blocks reliability with incombustible V0 PA6 body.
- Status follow up possibility by adding illumination unit.
- Strong polycarbonate button. Protective cable inlet tips enabling maximum safety.
- Minimum warm up, maximum life with protection LED' s.
- Position facility with badge and label kinds. Product variety fulfilling of all applications

Technical Information

| | |
|---|--|
| Mechanical Life | : 500.000 operations min. |
| Electrical Life | : 100.000 operations min. |
| Operating Temperature | : min./max. °C -5/+40 |
| Protection Degree | : IP20 = For contact block, IP50 = If the product is in panel or in box |
| Operating Frequency | : Without load 3000 operations/hour At full load 1200 operations/hour |
| Rated Operating Voltage Ue | : 250 V AC |
| Rated Operating Current Ie | : 4 A |
| Switching Power in AC 15 | : 1000 VA 1 kA |
| Insulation Voltage Ui | : 300 V |
| Stroke Resistance Voltage Uimp | : 2.5 kV |
| Standard Contact Material | : AgNi |
| Insulation Resistance | : 10 MΩ min. (500 V DC) |
| Dielectrical Strength | : Between body-contact 2000 V AC Open contact 1500 V AC |
| Connection Cable Cross-Section Standard | : 1.5-2.5 mm ² : UL 508 TS EN 60947-5-1 VDE0660 : IEC 60393-1 (for BPR Potentiometer) |



Genel Şema / General Scheme

| | | | |
|----|--|---|---|
| 1 | | 1) Düz Kafalı Yaylı Buton | 1) Round Push Button |
| 2 | | 2) Çıkık Kafalı Yaylı Buton | 2) Push Button High Position |
| 3 | | 3) Kalıcı Kafalı Yaylı Buton | 3) Push Button With Hold-On |
| 4 | | 4) Çiftli Düz Kafalı Yaylı Buton | 4) Double Head Push Button |
| 5 | | 5) Çiftli Çıkık Kafalı Yaylı Buton | 5) Double Head Push Button High Position |
| 6 | | 6) Mandallı Buton | 6) Handle Switch |
| 7 | | 7) Seçici Buton | 7) Selector Switch |
| 8 | | 8) ø 40 mm - ø 60 mm Mantar Kafalı Acil Stop Butonu | 8) ø 40 mm - ø 60 mm Mushroom Head Emergency Stop Push Button |
| 9 | | 9) ø 30 mm Silindirik Kafalı Acil Stop Butonu | 9) ø 30 mm Emergency Stop Push Button With Cylindrical Head |
| 10 | | 10) Mantar Kafalı Yaylı Buton | 10) Mushroom Head Push Button With Spring |
| 11 | | 11) Anahtarlı Buton | 11) Key Operated Push Button |
| 12 | | 12) Sinyal Lambası | 12) Signal Lamps |

| | | | |
|----|--|--|--|
| 13 | | 13) Acil Stop Etiket (Plastik/Alüminyum) ø 60 mm - ø 90 mm | 13) Plate ø 60 mm - ø 90 mm Emergency Stop (Plastic/Aluminium) |
| 14 | | 14) Rozet 8 mm-18 mm | 14) Badge 8 mm-18 mm |
| 15 | | 15) B Adaptör | 15) B Adapter |
| 16 | | 16) Start Kontak Blok - 100 | 16) Start Contact Block - 100 |
| 17 | | 17) Stop Kontak Blok - 200 | 17) Stop Contact Block - 200 |
| 18 | | 18) Çift Start - 101 | 18) Double Start - 101 |
| 19 | | 19) Çift Stop - 202 | 19) Double Stop - 202 |
| 20 | | 20) Start Stop - 102 | 20) Start Stop - 102 |
| 21 | | 21) Start Işık Bloklu | 21) Start Illumination Block |
| 22 | | 22) Stop Işık Bloklu | 22) Stop Illumination Block |
| 23 | | 23) Start Işık Blok Stop | 23) Start Illumination Block Stop |
| 24 | | 24) Işık Bloğu (Ledli veya neon ampul için) | 24) Illumination Block (With Led or Neon Lamp) |
| 25 | | 25) Emniyet Basma Düğmesi Darbe Muhafazası | 25) Emergency Push Button Plate Protection |
| 26 | | 26) Sıkıştırma Pulu | 26) Push Button Fixing Plate |

* Etiket Çeşitleri / Selection of Button Plates:

| |
|--|
| |
| |
| |
| |
| |
| |
| |

Kumanda Butonları

Push Buttons



B Serisi Kumanda Butonları Seçim Tablosu Series Push Buttons Selection Table

| Seri | Kontakt Blok Kombinasyonu | Buton Tipi | Renk |
|--|---|---|---|
| B | 1 K 2 | D | K |
| Series | Contact Block Combination | Button Type | Colour |
| B B Serisi Ø 22 mm Kumanda Butonu B Series Ø 22 mm Push Button | Kontakt Blok Tipi Contact Block Type 1 Start - Butonluk Start - For Button 2 Stop - Butonluk Stop - For Button | Yaylı Tip Butonlar Stringed Type Buttons D Düz, Yuvarlak Round F Kalıcı Stable H Çıkık, Yuvarlak High Position, Round M Mantar Ø 40 mm Mushroom Ø 40 mm Anahtarlı Tip Butonlar Key Operated Type Buttons A20 Anahtarlı, 2 Pozisyonlu (0-1) ↕ Key Operated, 2 Position (0-1) A21 Anahtarlı, 2 Pozisyonlu (0-1) ↕ Key Operated, 2 Position (0-1) A30 Anahtarlı, 3 Pozisyonlu (II-0-I) ↕↗ Key Operated, 3 Position (II-0-I) A31 Anahtarlı, 3 Pozisyonlu (II-0-I) ↕ Key Operated, 3 Position (II-0-I) "↕" Anahtarın çıkarılabildiği pozisyon Taking key out position Seçici Tip Butonlar Selector Switch Type Buttons S20 Seçici, 2 Pozisyonlu, Kalıcı (0-1) ↕ Selector Switch, 2 Position, Stable (0-1) S21 Seçici, 2 Pozisyonlu, Dönüşlü (0-1) ↕↗ Selector Switch, 2 Position, Rotational (0-1) S30 Seçici, 3 Pozisyonlu, Kalıcı (II-0-I) ↕ Selector Switch, 3 Position, Stable (II-0-I) S31 Seçici, 3 Pozisyonlu, Tek Dönüşlü (II-0-I) ↕↗ Selector Switch, 3 Position, Single Rotational (II-0-I) S32 Seçici, 3 Pozisyonlu, Çift Dönüşlü (II-0-I) ↕↗↖ Selector Switch, 3 Position, Double Rotational (II-0-I) Acil Stop Butonları Emergency Stop Buttons E30 Acil Stop, Silindirik Kafalı Ø 30 mm Emergency Stop, Cylindrical Head Ø 30 mm E Acil Stop Ø 40 mm Emergency Stop Ø 40 mm E-E Acil Stop Ø 40 mm Etiketli E60 Acil Stop Ø 60 mm Emergency Stop Ø 60 mm Çiftli Butonlar Double Head Buttons K20 Çiftli, Düz Kafalı Double Head K21 Çiftli, 1 Çıkık Kafalı Double Head, 1 High Position K22 Çiftli, 2 Çıkık Kafalı Yaylı Double Head, 2 High Position C Mandallı Buton Handle Switch X Sinyal Signal | Buton Rengi Button Colour B Beyaz White K Kırmızı Red M Mavi Blue S Sarı Yellow Y Yeşil Green H Siyah Mat Black Mat |
| | Işık Bloğu Tipi Illumination Block Type B 100-230 V AC/DC Beyaz Ledli 100-230 V AC/DC With White Led K 100-230 V AC/DC Kırmızı Ledli 100-230 V AC/DC With Red Led M 100-230 V AC/DC Mavi Ledli 100-230 V AC/DC With Blue Led S 100-230 V AC/DC Sarı Ledli 100-230 V AC/DC With Yellow Led Y 100-230 V AC/DC Yeşil Ledli 100-230 V AC/DC With Green Led 5 12-30 V AC/DC Beyaz Ledli 12-30 V AC/DC With White Led 6 12-30 V AC/DC Kırmızı Ledli 12-30 V AC/DC With Red Led 7 12-30 V AC/DC Mavi Ledli 12-30 V AC/DC With Blue Led 8 12-30 V AC/DC Sarı Ledli 12-30 V AC/DC With Yellow Led 9 12-30 V AC/DC Yeşil Ledli 12-30 V AC/DC With Green Led Q Özel Gerilim Beyaz Ledli Special Voltage With White Led X Özel Gerilim Kırmızı Ledli Special Voltage With Red Led V Özel Gerilim Mavi Ledli Special Voltage With Blue Led W Özel Gerilim Sarı Ledli Special Voltage With Yellow Led Z Özel Gerilim Yeşil Ledli Special Voltage With Green Led 3* Işıklı Blok - Ba9S Neon Ampule Uygun Duyulu Illumination Block - Suitable socket for Neon Lamp | | |

* Sadece B Serisi Kumanda Butonları İçin

* Only For B Series Push Buttons

Örnek: **B1K2DK** → Örnek olarak **B** serisi, start-stop, 100-230 V AC/DC kırmızı ledli, kırmızı renkli, düz, yuvarlak yaylı buton seçilmiştir.

Example: **B1K2DK** → For example, **B** series, start-stop, 100-230 V AC/DC with red led, red colored, round flat type button has been selected.

B Serisi Ø 22 mm Adaptörlü Kumanda Butonu Tipleri B Series Ø 22 mm Push Buttons With Adapter

| Sipariş Kodu Order Code | Kontakt Blok Tipi Contact Block Type | | Işık* Light | Buton Tipi Button Type | | Renk Colour |
|----------------------------|---|----------------------------------|----------------|---------------------------|---------------|----------------|
| | Normal Açık Normally Open | Normal Kapalı Normally Closed | | Düz Standard | Çıkık High | |
| B100DB | 1 | - | √ | √ | - | Beyaz/White |
| B100DK | 1 | - | √ | √ | - | Kırmızı/Red |
| B100DM | 1 | - | √ | √ | - | Mavi/Blue |
| B100DS | 1 | - | √ | √ | - | Sarı/Yellow |
| B100DY | 1 | - | √ | √ | - | Yeşil/Green |
| B100DH | 1 | - | - | √ | - | Siyah/Black |
| B101DB | 2 | - | √ | √ | - | Beyaz/White |
| B101DK | 2 | - | √ | √ | - | Kırmızı/Red |
| B101DM | 2 | - | √ | √ | - | Mavi/Blue |
| B101DS | 2 | - | √ | √ | - | Sarı/Yellow |
| B101DY | 2 | - | √ | √ | - | Yeşil/Green |
| B101DH | 2 | - | - | √ | - | Siyah/Black |
| B102DB | 1 | 1 | √ | √ | - | Beyaz/White |
| B102DK | 1 | 1 | √ | √ | - | Kırmızı/Red |
| B102DM | 1 | 1 | √ | √ | - | Mavi/Blue |
| B102DS | 1 | 1 | √ | √ | - | Sarı/Yellow |
| B102DY | 1 | 1 | √ | √ | - | Yeşil/Green |
| B102DH | 1 | 1 | - | √ | - | Siyah/Black |
| B200DB | - | 1 | √ | √ | - | Beyaz/White |
| B200DK | - | 1 | √ | √ | - | Kırmızı/Red |
| B200DM | - | 1 | √ | √ | - | Mavi/Blue |
| B200DS | - | 1 | √ | √ | - | Sarı/Yellow |
| B200DY | - | 1 | √ | √ | - | Yeşil/Green |
| B200DH | - | 1 | - | √ | - | Siyah/Black |
| B202DB | - | 2 | √ | √ | - | Beyaz/White |
| B202DK | - | 2 | √ | √ | - | Kırmızı/Red |
| B202DM | - | 2 | √ | √ | - | Mavi/Blue |
| B202DS | - | 2 | √ | √ | - | Sarı/Yellow |
| B202DY | - | 2 | √ | √ | - | Yeşil/Green |
| B202DH | - | 2 | - | √ | - | Siyah/Black |
| B100HB | 1 | - | √ | - | √ | Beyaz/White |
| B100HK | 1 | - | √ | - | √ | Kırmızı/Red |
| B100HM | 1 | - | √ | - | √ | Mavi/Blue |
| B100HS | 1 | - | √ | - | √ | Sarı/Yellow |
| B100HY | 1 | - | √ | - | √ | Yeşil/Green |
| B100HH | 1 | - | - | - | √ | Siyah/Black |
| B101HB | 2 | - | √ | - | √ | Beyaz/White |
| B101HK | 2 | - | √ | - | √ | Kırmızı/Red |
| B101HM | 2 | - | √ | - | √ | Mavi/Blue |
| B101HS | 2 | - | √ | - | √ | Sarı/Yellow |
| B101HY | 2 | - | √ | - | √ | Yeşil/Green |
| B101HH | 2 | - | - | - | √ | Siyah/Black |
| B102HB | 1 | 1 | √ | - | √ | Beyaz/White |
| B102HK | 1 | 1 | √ | - | √ | Kırmızı/Red |
| B102HM | 1 | 1 | √ | - | √ | Mavi/Blue |
| B102HS | 1 | 1 | √ | - | √ | Sarı/Yellow |
| B102HY | 1 | 1 | √ | - | √ | Yeşil/Green |
| B102HH | 1 | 1 | - | - | √ | Siyah/Black |
| B200HB | - | 1 | √ | - | √ | Beyaz/White |
| B200HK | - | 1 | √ | - | √ | Kırmızı/Red |
| B200HM | - | 1 | √ | - | √ | Mavi/Blue |
| B200HS | - | 1 | √ | - | √ | Sarı/Yellow |
| B200HY | - | 1 | √ | - | √ | Yeşil/Green |
| B200HH | - | 1 | - | - | √ | Siyah/Black |
| B202HB | - | 2 | √ | - | √ | Beyaz/White |
| B202HK | - | 2 | √ | - | √ | Kırmızı/Red |
| B202HM | - | 2 | √ | - | √ | Mavi/Blue |
| B202HS | - | 2 | √ | - | √ | Sarı/Yellow |
| B202HY | - | 2 | √ | - | √ | Yeşil/Green |
| B202HH | - | 2 | - | - | √ | Siyah/Black |



B100DY
Düz Kafalı Yaylı Buton
Round Push Button



B100DM
Düz Kafalı Yaylı Buton
Round Push Button



B100DH
Düz Kafalı Yaylı Buton
Round Push Button



B132DS
Düz Kafalı Yaylı Buton
Round Push Button



B200HK
Çıkık Kafalı Yaylı Buton
Push Button High Position

*: Işık Bloğu seçenekleri için bakınız sayfa 9 Kumanda Butonları Seçim Tablosu
*: See page 9 for illumination block selection - Push Buttons Selection Table

Kumanda Butonları

Push Buttons



B100FY

Kalıcı Kafalı Yaylı Buton
Push Button With Hold-On



B100MY

Mantar Kafalı Yaylı Buton
Mushroom Head Push Button



B102E30

ø 30 mm Silindirik Kafalı
Acil Stop Butonu
ø 30 mm Cylindrical Head
Emergency Stop Push Button



B200E-E

ø 40 mm Mantar Kafalı Acil Stop Butonu
ø 40 mm Mushroom Head
Emergency Stop Push Button



B200E

ø 40 mm Mantar Kafalı Acil Stop Butonu
ø 40 mm Mushroom Head
Emergency Stop Push Button



B200E60

ø 60 mm Mantar Kafalı Acil Stop Butonu
ø 60 mm Mushroom Head
Emergency Stop Push Button

B Serisi Ø 22 mm Adaptörlü Kumanda Butonu Tipleri B Series Ø 22 mm Push Buttons With Adapter

| Sipariş Kodu Order Code | Kontakt Blok Tipi Contact Block Type | | Işık* Light | Etiket Button Plates | Renk Colour |
|----------------------------|---|----------------------------------|----------------|-------------------------|----------------|
| | Normal Açık Normally Open | Normal Kapalı Normally Closed | | | |
| B100FY | 1 | - | √ | - | Yeşil/Green |
| B100FK | 1 | - | √ | - | Kırmızı/Red |
| B200FY | - | 1 | √ | - | Yeşil/Green |
| B200FK | - | 1 | √ | - | Kırmızı/Red |

* Sadece Ledli ışık bloğu takılabilmektedir.

Işık bloğu seçenekleri için bakınız sayfa 9 Kumanda Butonları Seçim Tablosu

* Assembly possibility only for LED contact block type

See page 9 for illumination block selection - Push Buttons Selection Table

| Sipariş Kodu Order Code | Kontakt Blok Tipi Contact Block Type | | Etiket Button Plates | Renk Colour |
|----------------------------|---|----------------------------------|-------------------------|----------------|
| | Normal Açık Normally Open | Normal Kapalı Normally Closed | | |
| B100MY | 1 | - | - | Yeşil/Green |
| B100MK | 1 | - | - | Kırmızı/Red |
| B100MH | 1 | - | - | Siyah/Black |
| B200MY | - | 1 | - | Yeşil/Green |
| B200MK | - | 1 | - | Kırmızı/Red |
| B200MH | - | 1 | - | Siyah/Black |
| B102MY | 1 | 1 | - | Yeşil/Green |
| B102MK | 1 | 1 | - | Kırmızı/Red |
| B102MH | 1 | 1 | - | Siyah/Black |

| Sipariş Kodu Order Code | Kontakt Blok Tipi Contact Block Type | | Etiket Button Plates | Renk Colour |
|----------------------------|---|----------------------------------|-------------------------|----------------|
| | Normal Açık Normally Open | Normal Kapalı Normally Closed | | |
| B200E30 | - | 1 | - | Kırmızı/Red |
| B102E30 | 1 | 1 | - | Kırmızı/Red |
| B100E30 | 1 | - | - | Kırmızı/Red |

| Sipariş Kodu Order Code | Kontakt Blok Tipi Contact Block Type | | Etiket Button Plates | Renk Colour |
|----------------------------|---|----------------------------------|-------------------------|----------------|
| | Normal Açık Normally Open | Normal Kapalı Normally Closed | | |
| B200E | - | 1 | - | Kırmızı/Red |
| B102E | 1 | 1 | - | Kırmızı/Red |
| B100E | 1 | - | - | Kırmızı/Red |
| B200E-E | - | 1 | √ | Kırmızı/Red |

| Sipariş Kodu Order Code | Kontakt Blok Tipi Contact Block Type | | Etiket Button Plates | Renk Colour |
|----------------------------|---|----------------------------------|-------------------------|----------------|
| | Normal Açık Normally Open | Normal Kapalı Normally Closed | | |
| B200E60 | - | 1 | - | Kırmızı/Red |
| B102E60 | 1 | 1 | - | Kırmızı/Red |
| B100E60 | 1 | - | - | Kırmızı/Red |

B Serisi Ø 22 mm Adaptörlü Kumanda Butonu Tipleri B Series Ø 22 mm Push Buttons With Adapter

| Sipariş Kodu Order Code | Kontakt Blok Tipi Contact Block Type | | Işık* Light | Etiket Button Plates | Buton Tipi Button Type | | Renk Colour |
|----------------------------|---|----------------------------------|----------------|-------------------------|---------------------------|------------------------|---|
| | Normal Açık Normally Open | Normal Kapalı Normally Closed | | | Düz Standard | Çıkık High Position | |
| B102K20KY | 1 | 1 | ✓ | - | ✓ | - | Kırmızı/Yeşil-Şeffaf Red/Green-Transp. |
| B102K21KY | 1 | 1 | ✓ | - | - | ✓ | Kırmızı/Yeşil-Şeffaf Red/Green-Transp. |
| B102K20HB | 1 | 1 | ✓ | - | ✓ | - | Siyah/Beyaz-Mat Black/White-Mat |
| B102K21HB | 1 | 1 | ✓ | - | - | ✓ | Siyah/Beyaz-Mat Black/White-Mat |

*: Işık Bloğu seçenekleri için bakınız sayfa 9 Kumanda Butonları Seçim Tablosu
*: See page 9 for illumination block selection - Push Buttons Selection Table

Not : Standart çiftli buton B102K20KY, kırmızı / yeşil ve şeffaftır.
Note : Standard double head push button is B102K20KY which is red/green and transparent.

Not : Çiftli butonda sadece kırmızı ve siyah renkli basma düğmeleri çıkıktır.
Note : For double head push button, only red and black colored buttons are at high position.



B132K20KY
Çiftli Düz Kafalı Yaylı Buton
Double and Flat Head Push Button With Spring



B132K21HB
Çiftli Çıkık Kafalı Yaylı Buton
Double Head High Position With Spring

| Sipariş Kodu Order Code | Kontakt Blok Tipi Contact Block Type | | Etiket Button Plates | Renk Colour |
|----------------------------|---|----------------------------------|-------------------------|----------------|
| | Normal Açık Normally Open | Normal Kapalı Normally Closed | | |
| B100C | 1 | - | - | Beyaz/White |
| B200C | - | 1 | - | Beyaz/White |
| B102C | 1 | 1 | - | Beyaz/White |



B100C
Mandallı Buton
Handle Switch

| Sipariş Kodu Order Code | Kontakt Blok Tipi Contact Block Type | | Işık* Light | Etiket Button Plates | Pozisyon Position |
|----------------------------|---|----------------------------------|----------------|-------------------------|---|
| | Normal Açık Normally Open | Normal Kapalı Normally Closed | | | |
| B100S20 | 1 | - | - | O-I | 2 Pozisyon - Kalıcı 2 Position - Stable |
| B100S21 | 1 | - | - | O-I | 2 Pozisyon - Dönüştürülebilir 2 Position - Rotational |
| B101S30 | 2 | - | - | II-O-I | 3 Pozisyon - Kalıcı 3 Position - Stable |
| B101S31 | 2 | - | - | II-O-I | 3 Pozisyon - Tek Dönüştürülebilir 3 Position - Rotational |
| B101S32 | 2 | - | - | II-O-I | 3 Pozisyon - Çift Dönüştürülebilir 3 Position - Unfixable |
| B100SL20 | 1 | - | ✓ | O-I | 2 Pozisyon - Kalıcı 2 Position - Stable |
| B100SL21 | 1 | - | ✓ | O-I | 2 Pozisyon - Dönüştürülebilir 2 Position - Rotational |
| B101SL30 | 2 | - | ✓ | II-O-I | 2 Pozisyon - Kalıcı 3 Position - Stable |
| B101SL31 | 2 | - | ✓ | II-O-I | 3 Pozisyon - Tek Dönüştürülebilir 3 Position - Rotational |
| B101SL32 | 2 | - | ✓ | II-O-I | 3 Pozisyon - Çift Dönüştürülebilir 3 Position - Rotational |

*: Işık Bloğu seçenekleri için bakınız sayfa 9 Kumanda Butonları Seçim Tablosu
*: See page 9 for illumination block selection - Push Buttons Selection Table



B100S20
Işıksız Tip Seçici Buton
Selector Switch Without Light



B131SL30Y
Işıklı Tip Seçici Buton
Selector Switch With Light

Kumanda Butonları

Push Buttons



B030XK

Sinyal Lambası ø 22 mm
Signal Lamps ø 22 mm

| Sipariş Kodu Order Code | Işık Light | | Nominal Gerilim Nominal Voltage | Renk Colour |
|----------------------------|----------------------------|--------------|------------------------------------|----------------|
| | Ampul Takılabilen Light | Ledli Led | | |
| B030XB | 1 | - | - | Beyaz/White |
| B030XK | 1 | - | - | Kırmızı/Red |
| B030XM | 1 | - | - | Mavi/Blue |
| B030XS | 1 | - | - | Sarı/Yellow |
| B030XY | 1 | - | - | Yeşil/Green |
| B050XB | - | 1 | 12-30 V AC/DC | Beyaz/White |
| B060XK | - | 1 | 12-30 V AC/DC | Kırmızı/Red |
| B070XM | - | 1 | 12-30 V AC/DC | Mavi/Blue |
| B080XS | - | 1 | 12-30 V AC/DC | Sarı/Yellow |
| B090XY | - | 1 | 12-30 V AC/DC | Yeşil/Green |
| B0B0XB | - | 1 | 100-230 V AC/DC | Beyaz/White |
| B0K0XK | - | 1 | 100-230 V AC/DC | Kırmızı/Red |
| B0M0XM | - | 1 | 100-230 V AC/DC | Mavi/Blue |
| B0S0XS | - | 1 | 100-230 V AC/DC | Sarı/Yellow |
| B0Y0XY | - | 1 | 100-230 V AC/DC | Yeşil/Green |

POTANSİYOMETRE POTENTIOMETER



BPR5K

5K Potansiyometre
5K Potentiometer

| | Sipariş Kodu / Order Code | | |
|--|---------------------------|--------|--------|
| | BPR01K | BPR05K | BPR10K |
| Empedans (R) Impedance (R) | 1 kΩ | 5 kΩ | 10 kΩ |
| Anma Gücü (P) Rated Power (P) | Lineer 1,5W (70°C) | | |
| Koruma Sınıfı Protection Degree | IP65 | | |
| İzolasyon Direnci Isolation Resistance | min 10 MΩ (500V DC) | | |
| Çalışma Sıcaklığı Operating Temperature | -5°C / +40°C | | |
| Direnc Elemanı Resistive Element | Sermet Cermet | | |
| Elektriksel Kurs Turning Range | 270° ± 15° | | |
| Tolerans Tolerance | ± %10 | | |
| Isı Katsayısı Thermal Coefficient | %100 ppm/°C | | |
| Dielektrik Dayanımı Dielectric Endurance | ± 1750 Vrms | | |
| Klimatik Kategori Climatic Category | 55/125/56 | | |
| Maksimum Çalışma Gerilimi (V) Maximum Operating Voltage (V) | 38.70 | 86.60 | 122.50 |
| Maksimum Fırça Akımı (mA) Maximum Brush Current (mA) | 38.70 | 17.30 | 12.20 |

B Serisi Ø 22 mm Adaptörlü Kumanda Butonu Tipleri B Series Ø 22 mm Push Buttons With Adapter

| Sipariş Kodu Order Code | Kontakt Blok Tipi Contact Block Type | | Etiket Button Plates | Pozisyon Position |
|----------------------------|---|----------------------------------|-------------------------|--------------------------|
| | Normal Açık Normally Open | Normal Kapalı Normally Closed | | |
| B100A20 | 1 | - | 0-I | 2 Pozisyon 2 Position |
| B100A21 | 1 | - | 0-I | 2 Pozisyon 2 Position |
| B102A20 | 1 | 1 | 0-I | 2 Pozisyon 2 Position |
| B102A21 | 1 | 1 | 0-I | 2 Pozisyon 2 Position |
| B102A30 | 1 | 1 | II-0-I | 3 Pozisyon 3 Position |
| B102A31 | 1 | 1 | II-0-I | 3 Pozisyon 3 Position |

⌚: Bu sembol anahtarın çıkarılabildiği pozisyonu gösterir.
⌚: This symbol indicates the position of key-rollback.



B102A31

Anahtarlı Buton
Key Operated Push Button

B Serisi Ø 22 mm Adaptörlü Kumanda Butonu Kontakt Blok Tipleri B Series Ø 22 mm Contact Block Types For Push Buttons With Adapter

| Sipariş Kodu Order Code | Kontakt Tipi Contact Type | | Işık Light | | Nominal Akım Nominal Current | Nominal Gerilim Nominal Voltage | Renk Colour |
|----------------------------|------------------------------|----------------------------------|-----------------------------|--------------|---------------------------------|------------------------------------|----------------|
| | Normal Açık Normally Open | Normal Kapalı Normally Closed | Ampul Takılabilen* Light | Ledli Led | | | |
| B1 | 1 | - | - | - | 4A | 250 V | - |
| B2 | - | 1 | - | - | 4A | 250 V | - |
| B3 | - | - | 1 | - | - | - | - |
| B5 | - | - | - | 1 | 5-15 mA | 12-30 V AC/DC | Beyaz/White |
| B6 | - | - | - | 1 | 5-15 mA | 12-30 V AC/DC | Kırmızı/Red |
| B7 | - | - | - | 1 | 5-15 mA | 12-30 V AC/DC | Mavi/Blue |
| B8 | - | - | - | 1 | 5-15 mA | 12-30 V AC/DC | Sarı/Yellow |
| B9 | - | - | - | 1 | 5-15 mA | 12-30 V AC/DC | Yeşil/Green |
| BB | - | - | - | 1 | 2-5 mA | 100-230 V AC | Beyaz/White |
| BK | - | - | - | 1 | 2-5 mA | 100-230 V AC | Kırmızı/Red |
| BM | - | - | - | 1 | 2-5 mA | 100-230 V AC | Mavi/Blue |
| BS | - | - | - | 1 | 2-5 mA | 100-230 V AC | Sarı/Yellow |
| BY | - | - | - | 1 | 2-5 mA | 100-230 V AC | Yeşil/Green |
| BB-4 | - | - | - | 1 | 4-5 mA | 110 V AC/DC | Beyaz/White |
| BK-4 | - | - | - | 1 | 4-5 mA | 110 V AC/DC | Kırmızı/Red |
| BM-4 | - | - | - | 1 | 4-5 mA | 110 V AC/DC | Mavi/Blue |
| BS-4 | - | - | - | 1 | 4-5 mA | 110 V AC/DC | Sarı/Yellow |
| BY-4 | - | - | - | 1 | 4-5 mA | 110 V AC/DC | Yeşil/Green |

*: Max. 2W'lık Ba9S duylu Neon Ampul takılabilir.
*: Assembly possibility only for Neon Lamp with max. 2W socket.

Not : Maksimum 3 adet kontakt blok arka arkaya eklenebilir.
Note : Max. 3 contact blocks can be added subsequently.



B1

B2

Start ve Stop Kontakt Blokları
Contact Blocks Start-Stop



B9

B3

Ledli ve Ampul Takılabilen
Işıklı Bloklar
Illumination Blocks With LED and Neon
Lamp Assembly Possibility

Kumanda Butonları

Push Buttons



Aksesuarlar / Accessories



BEB

ø 22 mm Etanj Başlık
ø 22 mm Waterproof Cover



B-ROZET08

Rozet 8 mm
Badge Base 8 mm



B-ROZET18

Rozet 18 mm
Badge Base 18 mm



B-MUHAFAZA

Emniyet Basma Düğmesi
Darbe Muhafazası
Emergency Push Button
Plate Protection



B-PUL

Buton Sıkıştırma Pulu
Push Button Fixing Plate



BET18

Etiket 18 mm Boş
Plate 18 mm Empty



BET08

Etiket 8 mm Boş
Plate 8 mm Empty

START

BET08-START

Etiket 8 mm START
Plate 8 mm START

STOP

BET08-STOP

Etiket 8 mm STOP
Plate 8 mm STOP

O I

BET01

Etiket 8 mm O-I
Plate 8 mm O-I

O I

BET01-OK

Etiket 8 mm O-I
Plate 8 mm O-I

II O I

BET201

Etiket 8 mm II-O-I
Plate 8 mm II-O-I

II O I

BET201-OK

Etiket 8 mm
Plate 8 mm

II O I

BET201-OK2

Etiket 8 mm II-O-I
Plate 8 mm II-O-I



BET60P (Plastik/Plastic) BET60A (Alüminyum/Aluminium)

Etiket ø 60 mm Acil Stop
Plate ø 60 mm Emergency Stop



BET90P (Plastik/Plastic) BET90A (Alüminyum/Aluminium)

Etiket ø 90 mm Acil Stop
Plate ø 90 mm Emergency Stop

| Sipariş Kodu Order Code | Etiket Yazısı Plate | Renk Colour |
|----------------------------|------------------------|-----------------------------------|
| BET08 | - | Gri/Grey |
| BET18 | - | Gri/Grey |
| BET08-START | START | Gri/Grey |
| BET08-STOP | STOP | Gri/Grey |
| BET08-01 | O-I | Gri/Grey |
| BET08-01OK | O-I | Gri/Grey |
| BET08-201 | II-O-I | Gri/Grey |
| BET08-201OK | II-O-I | Gri/Grey |
| BET08-201OK2 | II-O-I | Gri/Grey |
| BET60P | EMERGENCY STOP | Sarı/Yellow |
| BET90P | EMERGENCY STOP | Sarı/Yellow |
| BET60A | EMERGENCY STOP | Sarı/Yellow - Alüminyum/Aluminium |
| BET90A | EMERGENCY STOP | Sarı/Yellow - Alüminyum/Aluminium |

Montaj Şekli / Assembly

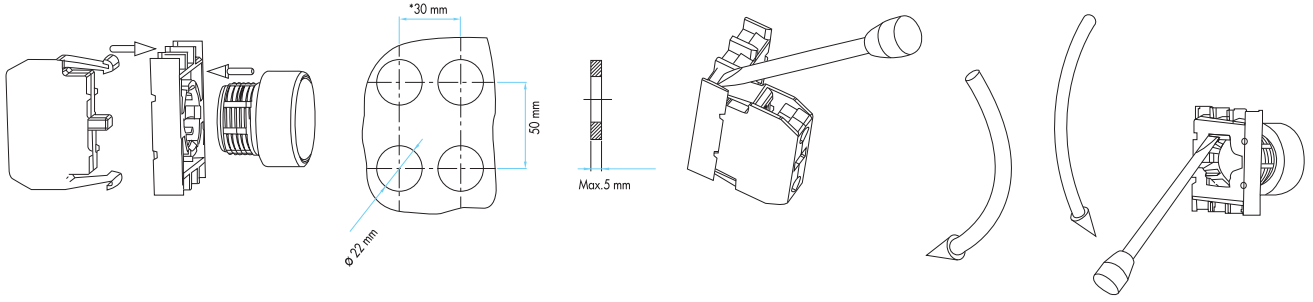

*Emniyet ve mantar butonlarında montaj aralığı 30 mm yerine maks. 75 mm'ye kadar çıkar.
The mounting distance in emergency and mushroom buttons increases up to max. 75 mm instead of 30 mm

Boyutlar (mm) / Dimensions (mm)

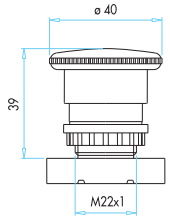

Acil Stop \varnothing 40 mm
Emergency Stop \varnothing 40 mm

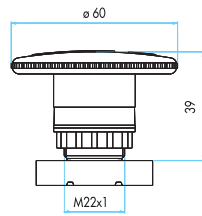

Acil Stop \varnothing 60 mm
Emergency Stop \varnothing 60 mm

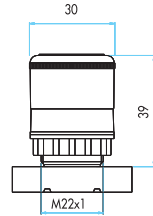

Acil Stop \varnothing 30 mm
Emergency Stop \varnothing 30 mm

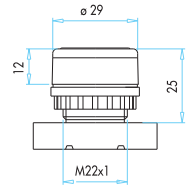

Düz, Yaylı
Round

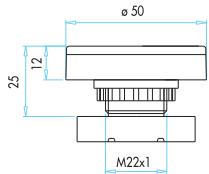

Çiftli Düz Kafalı, Yaylı
Double Head

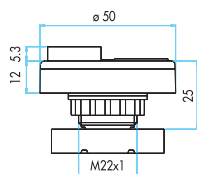

Çiftli Çıkık Kafalı, Yaylı
Double Head High Position

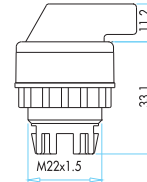

Seçici
Selector

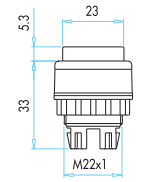

Çıkık Kafalı, Yaylı
Round Button High Position

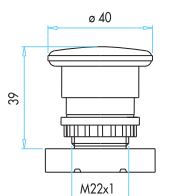

Mantar, Yaylı
Mushroom

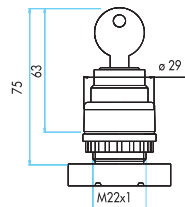

Anahtarlı
Key Operated

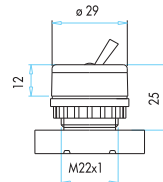

Mandallı
Handle

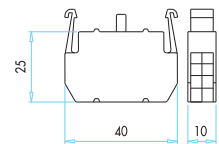

B Serisi Kontak Blok
B Series Contact Block

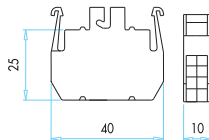

B Serisi Ampul Takılabilen Işıklı Blok
Neon Lamp Mountable
B Series Light Block

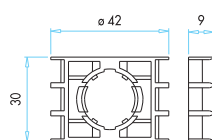

Adaptör
Adapter

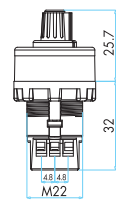

Potansiyometre
Potentiometer



CP Plastik Serisi Ø 22 mm Adaptörlü Kumanda Butonları (IP65)

- İşlevsel özellikleri artırılmış ve basma düğmesinden kolaylıkla sökülebilen adaptör.
- Lego mantığı ile ardarda eklenebilen ve montaj mesafesini azaltan küçük tasarımı kontak bloklar.
- İnsan hayatına değer veren (V0) PA6 gövde ile kontak blokların güvenilirliği.
- Işıklı blok eklenerek durum takip kolaylığı.
- Silikon conta kullanılmış IP65 koruma sınıflı ve parmak ergonomisine daha uygun; estetik basma düğmesi.
- Can güvenliği açısından korumalı kablo giriş uçları.
- Korumalı LED'ler ile minimum ısınma, maksimum ömür.
- Rozet ve etiket çeşitleri ile konumlandırma imkanı.
- Tüm uygulamalara cevap verecek ürün çeşitliliği.

Teknik Bilgiler

| | |
|--------------------------------|---|
| Mekanik Ömür | : 500.000 açma-kapama min. |
| Elektriksel Ömür | : 100.000 açma-kapama min. |
| Çalışma Sıcaklığı | : min./maks. °C -5/+40 |
| Koruma Sınıfı | : IP65 |
| Çalışma Sıklığı | : Yüksüz 3000 açma-kapama/saat Yükte 1200 açma-kapama/saat |
| Anma İşletme Gerilimi Ue | : 250 V AC |
| Anma İşletme Akımı Ie | : 4 A |
| Yalıtım Gerilimi Ui | : 300 V |
| Darbe Dayanım Gerilimi Uimp | : 2.5 kV |
| Standart Kontak Malzemesi | : AgNi |
| İzolasyon Direnci | : 10 MΩ min. (500 V DC) |
| Dielektrik Mukavemeti | : Gövde-Kontak arası 2000 V AC Açık Kontak 1500 V AC |
| Bağlantı Kablo Kesiti Standart | : 1.5-2.5 mm ² : TS EN 60947-5-1 VDE0660 |



CP Plastic Series Ø 22 mm Push Buttons With Adapter (IP65)

- Functional specifications are maximized and adapter, which is facilitated to take apart easily.
- Sequential connectable body and contact blocks after lego logic.
- Contact blocks reliability with incombustible V0 PA6 body.
- Status follow up possibility by adding illumination unit.
- IP65 Protection degree with silicon band, finger ergonomic and aesthetic button.
- Protective cable inlet tips enabling maximum safety
- Minimum warm up, maximum life with protection LED's.
- Position facility with badge and label kinds.
- Product variety, fulfilling of all applications.

Technical Information

| | |
|---|--|
| Mechanical Life | : 500.000 operations min. |
| Electrical Life | : 100.000 operations min. |
| Operating Temperature | : min./max. °C -5/+40 |
| Protection Degree | : IP65 |
| Operating Frequency | : Without load 3000 operations/hour At full load 1200 operations/hour |
| Rated Operating Voltage Ue | : 250 V AC |
| Rated Operating Current Ie | : 4 A |
| Insulation Voltage Ui | : 300 V |
| Stroke Resistance Voltage Uimp | : 2.5 kV |
| Standard Contact Material | : AgNi |
| Insulation Resistance | : 10 MΩ min. (500 V DC) |
| Dielectrical Strength | : Between body-contact 2000 V AC Open contact 1500 V AC |
| Connection Cable Cross-Section Standard | : 1.5-2.5 mm ² : TS EN 60947-5-1 VDE0660 |



Genel Şema / General Scheme

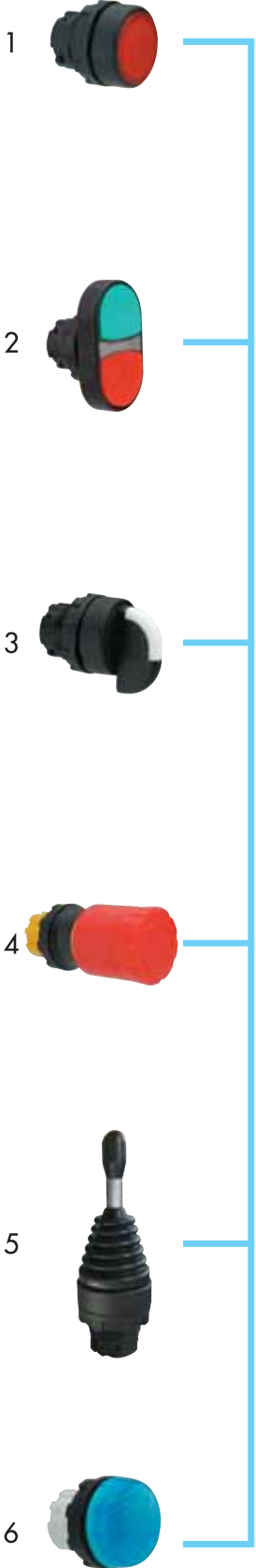

- 1) Düz Kafalı Yaylı Buton
- 2) Çiftli Düz Kafalı Yaylı Buton
- 3) Seçici Buton
- 4) ø 30 mm Acil Stop Butonu
- 5) Joyistik Buton
- 6) Sinyal Lambası

- 1) Round Push Button
- 2) Double Head Push Button
- 3) Selector Switch
- 4) Emergency Stop Button - ø 30 mm
- 5) Joystick Button
- 6) Signal Lamps

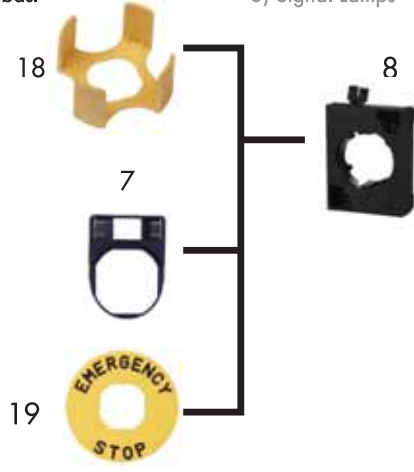

- 7) Rozet 8 mm-18 mm
- 8) C Adaptör
- 9) Start Kontak Blok - 100
- 10) Stop Kontak Blok - 200
- 11) Çift Start - 101
- 12) Çift Stop - 202
- 13) Start Stop - 102
- 14) Start Işık Bloklü
- 15) Stop Işık Bloklü
- 16) Start Işık Blok Stop
- 17) Ledli Işık Bloğu
Emniyet Basma Düğmesi
- 18) Darbe Muhafazası
Acil Stop Etiketli (Plastik/Alüminyum)
- 19) ø 60 mm - ø 90 mm

- 7) Badge 8 mm-18 mm
- 8) C Adapter
- 9) Start Contact Block - 100
- 10) Stop Contact Block - 200
- 11) Double Start - 101
- 12) Double Stop - 202
- 13) Start Stop - 102
- 14) Start Illumination Block
- 15) Stop Illumination Block
- 16) Start Illumination Block Stop
- 17) Illumination Block
Emergency Push Button
- 18) Plate Protection
Plate ø 60 mm - ø 90 mm
- 19) Emergency Stop (Plastic/Aluminium)

* Etiket Çeşitleri / Selection of Button Plates:

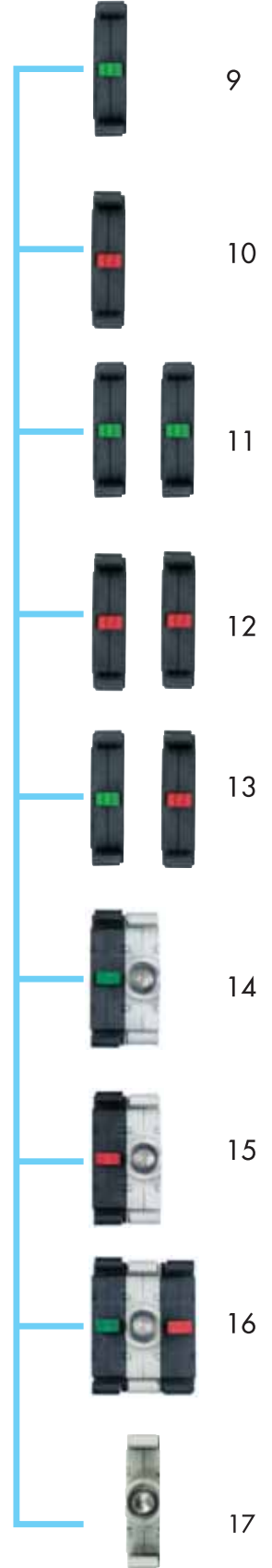



CM Metal Serisi Ø 22 mm Adaptörlü Kumanda Butonları (IP65)

- İşlevsel özellikleri artırılmış ve basma düğmesinden kolaylıkla sökülebilen adaptör.
- Lego mantığı ile aralarda eklenebilen ve montaj mesafesini azaltan küçük tasarımı kontak bloklar.
- İnsan hayatına değer veren (V0) PA6 gövde ile kontak blokların güvenilirliği.
- Işıklı blok eklenerek durum takip kolaylığı.
- Silikon conta kullanılmış IP65 koruma sınıfı ve parmak ergonomisine daha uygun estetik basma düğmesi.
- Ağır koşullara dayatıklı metal gövdeli basma düğmeleri.
- Pano montajını daha sağlam yapan metal montaj bileziği.
- Can güvenliği açısından korumalı kablo giriş uçları.
- Korumalı LED'ler ile minimum ısına, maksimum ömür.
- Rozet ve etiket çeşitleri ile konumlandırma imkanı.
- Tüm uygulamalara cevap verecek ürün çeşitliliği.

Teknik Bilgiler

| | |
|--------------------------------|---|
| Mekanik Ömür | : 500.000 açma-kapama min. |
| Elektriksel Ömür | : 100.000 açma-kapama min. |
| Çalışma Sıcaklığı | : min./maks. °C -5/+40 |
| Koruma Sınıfı | : IP65 |
| Çalışma Sıklığı | : Yüksüz 3000 açma-kapama/saat Yükte 1200 açma-kapama/saat |
| Anma İşletme Gerilimi Ue | : 250 V AC |
| Anma İşletme Akımı Ie | : 4 A |
| Yalıtım Gerilimi Ui | : 300 V |
| Darbe Dayanım Gerilimi Uimp | : 2.5 kV |
| Standart Kontak Malzemesi | : AgNi |
| İzolasyon Direnci | : 10 MΩ min. (500 V DC) |
| Dielektrik Mukavemeti | : Gövde-Kontakt arası 2000 V AC Açık Kontakt 1500 V AC |
| Bağlantı Kablo Kesiti Standart | : 1.5-2.5 mm ² TS EN 60947-5-1 VDE0660 |



CM Metal Series Ø22 mm Push Buttons With Adapter (IP65)

- Functional specifications are maximized and adapter, which is facilitated to take apart easily.
- Sequential connectable body and contact blocks after lego logic.
- Contact blocks reliability with incombustible V0 PA6 body.
- Status follow up possibility by adding illumination unit.
- In heavy conditions enduring metal construction push buttons.
- Metal mounting bracelet strengthening panel mounting
- Protective cable inlet tips enabling maximum safety
- Minimum warm up, maximum life with protection LED's.
- Position facility with badge and label kinds.
- Product variety fulfilling of all applications.
- IP65 Protection degree with silicon band, finger ergonomic and aesthetic button.

Technical Information

| | |
|---|--|
| Mechanical Life | : 500.000 operations min. |
| Electrical Life | : 100.000 operations min. |
| Operating Temperature | : min./max. °C -5/+40 |
| Protection Degree | : IP65 |
| Operating Frequency | : Without load 3000 operations/hour At full load 1200 operations/hour |
| Rated Operating Voltage Ue | : 250 V AC |
| Rated Operating Current Ie | : 4 A |
| Insulation Voltage Ui | : 300 V |
| Stroke Resistance Voltage Uimp | : 2.5 kV |
| Standard Contact Material | : AgNi |
| Insulation Resistance | : 10 MΩ min. (500 V DC) |
| Dielectrical Strength | : Between body-contact 2000 V AC Open contact 1500 V AC |
| Connection Cable Cross-Section Standard | : 1.5-2.5 mm ² TS EN 60947-5-1 VDE0660 |



Genel Şema / General Scheme



- 1) Düz Kafalı Yaylı Buton
- 2) Çiftli Düz Kafalı Yaylı Buton
- 3) Seçici Buton
- 4) Joyistik Buton
- 5) Sinyal Lambası

- 1) Round Push Button With Spring
- 2) Double Head Push Button
- 3) Selector Switch
- 4) Joystick Button
- 5) Signal Lamps



- 6) Rozet 8 mm-18 mm
 - 7) C Adaptör
 - 8) CM Montaj Bileziği (Metal)
 - 9) Start Kontak Blok - 100
 - 10) Stop Kontak Blok - 200
 - 11) Çift Start - 101
 - 12) Çift Stop - 202
 - 13) Start Stop - 102
 - 14) Start Işık Bloklü
 - 15) Stop Işık Bloklü
 - 16) Start Işık Blok Stop
 - 17) Ledli Işık Bloğu
 - 19) Darbe Muhafazası
- Acil Stop Etiketli (Plastik/Alüminyum)
ø 60 mm - ø 90 mm

- 6) Badge 8 mm-18 mm
 - 7) C Adapter
 - 8) CM Mounting bracelet (Metal)
 - 9) Start Contact Block - 100
 - 10) Stop Contact Block - 200
 - 11) Double Start - 101
 - 12) Double Stop - 202
 - 13) Start Stop - 102
 - 14) Start Illumination Block
 - 15) Stop Illumination Block
 - 16) Start Illumination Block Stop
 - 17) Led Illumination Block
 - 19) Plate Protection
- Plate ø 60 mm - ø 90 mm
Emergency Stop (Plastic/Aluminium)

* Etiket Çeşitleri / Selection of Button Plates:



9

10

11

12

13

14

15

16

17



C Serisi Kumanda Butonları Seçim Tablosu

Series Push Buttons Selection Table

| Seri | Kontakt Blok Kombinasyonu | Buton Tipi | Renk |
|---|---|--|---|
| CM | 1 K 2 | D | K |
| Series | Contact Block Combination | Button Type | Colour |
| <p>CP CP Plastik Serisi ø 22 mm Kumanda Butonu B Series ø 22 mm Push Button</p> <p>CM CM Metal Serisi ø 22 mm Kumanda Butonu C Series ø 22 mm Push Button</p> | <p>1 Start - Butonluk Start - For Button</p> <p>2 Stop - Butonluk Stop - For Button</p> <p>3 Yanyana Start - Start Start - Start Tandem</p> <p>4 Yanyana Start - Stop Start - Stop Tandem</p> <p>5 Yanyana Stop - Stop Stop - Stop Tandem</p> <p>6 Start - Start Düşey Start - Start Vertical</p> <p>7 Start - Stop Düşey Start - Stop Vertical</p> <p>8 Stop - Stop Düşey Stop - Stop Vertical</p> <p>9 Start - Stop Tek Kontakta Start - Stop at One Contact</p> | <p>D Düz, Yuvarlak Round</p> <p>S20 Seçici, 2 Pozisyonlu, Kalkıcı (0-1) Selector Switch, 2 Position, Stable (0-1) ✓</p> <p>S21 Seçici, 2 Pozisyonlu, Dönüşlü (0-1) Selector Switch, 2 Position, Rotational (0-1) ↕</p> <p>S30 Seçici, 3 Pozisyonlu, Kalkıcı (II-0-I) ✓ Selector Switch, 3 Position, Stable (II-0-I)</p> <p>S31 Seçici, 3 Pozisyonlu, Tek Dönüşlü (II-0-I) ↕ Selector Switch, 3 Position, Single Rotational (II-0-I)</p> <p>S32 Seçici, 3 Pozisyonlu, Çift Dönüşlü (II-0-I) ↕↕ Selector Switch, 3 Position Double Rotational (II-0-I)</p> <p>DJ20 Joyistik, 2 Pozisyonlu, Kalkıcı Joystick, 2 Position, Stable</p> <p>DJ21 Joyistik, 2 Pozisyonlu, Dönüşlü Joystick, 2 Position, Rotational</p> <p>DJ40 Joyistik, 4 Pozisyonlu, Kalkıcı Joystick, 4 Position, Stable</p> <p>DJ41 Joyistik, 4 Pozisyonlu, Dönüşlü Joystick, 4 Position, Rotational</p> | <p>B Beyaz White</p> <p>K Kırmızı Red</p> <p>M Mavi Blue</p> <p>S Sarı Yellow</p> <p>Y Yeşil Green</p> <p>H Siyah Mat Black Mat</p> |
| | <p>Işık Bloğu Tipi Illumination Block Type</p> <p>B 100-230 V AC/DC Beyaz Ledli 100-230 V AC/DC With White Led</p> <p>K 100-230 V AC/DC Kırmızı Ledli 100-230 V AC/DC With Red Led</p> <p>M 100-230 V AC/DC Mavi Ledli 100-230 V AC/DC With Blue Led</p> <p>S 100-230 V AC/DC Sarı Ledli 100-230 V AC/DC With Yellow Led</p> <p>Y 100-230 V AC/DC Yeşil Ledli 100-230 V AC/DC With Green Led</p> <p>5 12-30 V AC/DC Beyaz Ledli 12-30 V AC/DC With White Led</p> <p>6 12-30 V AC/DC Kırmızı Ledli 12-30 V AC/DC With Red Led</p> <p>7 12-30 V AC/DC Mavi Ledli 12-30 V AC/DC With Blue Led</p> <p>8 12-30 V AC/DC Sarı Ledli 12-30 V AC/DC With Yellow Led</p> <p>9 12-30 V AC/DC Yeşil Ledli 12-30 V AC/DC With Green Led</p> <p>Q Özel Gerilim Beyaz Ledli Special Voltage With White Led</p> <p>X Özel Gerilim Kırmızı Ledli Special Voltage With Red Led</p> <p>V Özel Gerilim Mavi Ledli Special Voltage With Blue Led</p> <p>W Özel Gerilim Sarı Ledli Special Voltage With Yellow Led</p> <p>Z Özel Gerilim Yeşil Ledli Special Voltage With Green Led</p> | <p>Yaylı Tip Butonlar Stringed Type Buttons</p> <p>D Düz, Yuvarlak Round</p> <p>Seçici Tip Butonlar Selector Switch Type Buttons</p> <p>Joyistik Tip Butonlar Joystick Type Buttons</p> <p>Şoklu Tip Acil Stop Butonları (Sadece CP Plastik Serisi İçin) Emergency Stop Buttons, Twist On/Release On (Only For CP Plastic Series)</p> <p>E30 Acil Stop ø 30 mm, Çevirmeli Şoklu* Emergency Stop ø 30 mm, Twist On</p> <p>EA30 Acil Stop ø 30 mm, Anahtarlı, Çevirmeli Şoklu* Emergency Stop ø 30 mm, Twist On, Key Operated</p> <p>ES30 Acil Stop ø 30 mm, Sinyalli, Çevirmeli Şoklu* Emergency Stop ø 30 mm, Twist On, With Signal</p> <p>ECN30 Acil Stop ø 30 mm, Çekmeli Şoklu* Emergency Stop ø 30 mm, Release On</p> <p>ECS30 Acil Stop ø 30 mm, Sinyalli, Çekmeli Şoklu* Emergency Stop ø 30 mm, With Signal, Release On</p> <p>*: Ani Kilitlemeli *: Sudden Locking</p> <p>Çiftli Butonlar Double Head Buttons</p> <p>K20 Çiftli, Düz Kafalı Double Head</p> <p>K21 Çiftli, 1 Çıkık Kafalı</p> <p>X Sinyal Signal</p> | |

Örnek: **CM1K2DK** → Örnek olarak **CM** metal serisi, start-stop, 100-230 V AC/DC kırmızı ledli, kırmızı renkli, düz, yuvarlak yaylı buton seçilmiştir.

Example: **CM1K2DK** → For example, **CM** series, start-stop, 100-230 V AC/DC with red led, red, round type button has been selected.

C Serisi Ø 22 mm Adaptörlü Kumanda Butonu Tipleri C Series Ø 22 mm Push Buttons With Adapter

| Sipariş Kodu Order Code | Kontakt Blok Tipi Contact Block Type | | İşık* Light | Buton Tipi Button Type | Renk Colour |
|----------------------------|---|----------------------------------|----------------|---------------------------|----------------|
| | Normal Açık Normally Open | Normal Kapalı Normally Closed | Ledli Led | Düz Standard | |
| CP100DB | 1 | - | √ | √ | Beyaz/White |
| CP100DK | 1 | - | √ | √ | Kırmızı/Red |
| CP100DM | 1 | - | √ | √ | Mavi/Blue |
| CP100DS | 1 | - | √ | √ | Sarı/Yellow |
| CP100DY | 1 | - | √ | √ | Yeşil/Green |
| CP100DH | 1 | - | - | √ | Siyah/Black |
| CP101DB | 2 | - | √ | √ | Beyaz/White |
| CP101DK | 2 | - | √ | √ | Kırmızı/Red |
| CP101DM | 2 | - | √ | √ | Mavi/Blue |
| CP101DS | 2 | - | √ | √ | Sarı/Yellow |
| CP101DY | 2 | - | √ | √ | Yeşil/Green |
| CP101DH | 2 | - | - | √ | Siyah/Black |
| CP102DB | 1 | 1 | √ | √ | Beyaz/White |
| CP102DK | 1 | 1 | √ | √ | Kırmızı/Red |
| CP102DM | 1 | 1 | √ | √ | Mavi/Blue |
| CP102DS | 1 | 1 | √ | √ | Sarı/Yellow |
| CP102DY | 1 | 1 | √ | √ | Yeşil/Green |
| CP102DH | 1 | 1 | - | √ | Siyah/Black |
| CP200DB | - | 1 | √ | √ | Beyaz/White |
| CP200DK | - | 1 | √ | √ | Kırmızı/Red |
| CP200DM | - | 1 | √ | √ | Mavi/Blue |
| CP200DS | - | 1 | √ | √ | Sarı/Yellow |
| CP200DY | - | 1 | √ | √ | Yeşil/Green |
| CP200DH | - | 1 | - | √ | Siyah/Black |
| CP202DB | - | 2 | √ | √ | Beyaz/White |
| CP202DK | - | 2 | √ | √ | Kırmızı/Red |
| CP202DM | - | 2 | √ | √ | Mavi/Blue |
| CP202DS | - | 2 | √ | √ | Sarı/Yellow |
| CP202DY | - | 2 | √ | √ | Yeşil/Green |
| CP202DH | - | 2 | - | √ | Siyah/Black |
| CM100DB | 1 | - | √ | √ | Beyaz/White |
| CM100DK | 1 | - | √ | √ | Kırmızı/Red |
| CM100DM | 1 | - | √ | √ | Mavi/Blue |
| CM100DS | 1 | - | √ | √ | Sarı/Yellow |
| CM100DY | 1 | - | √ | √ | Yeşil/Green |
| CM100DH | 1 | - | - | √ | Siyah/Black |
| CM101DB | 2 | - | √ | √ | Beyaz/White |
| CM101DK | 2 | - | √ | √ | Kırmızı/Red |
| CM101DM | 2 | - | √ | √ | Mavi/Blue |
| CM101DS | 2 | - | √ | √ | Sarı/Yellow |
| CM101DY | 2 | - | √ | √ | Yeşil/Green |
| CM101DH | 2 | - | - | √ | Siyah/Black |
| CM102DB | 1 | 1 | √ | √ | Beyaz/White |
| CM102DK | 1 | 1 | √ | √ | Kırmızı/Red |
| CM102DM | 1 | 1 | √ | √ | Mavi/Blue |
| CM102DS | 1 | 1 | √ | √ | Sarı/Yellow |
| CM102DY | 1 | 1 | √ | √ | Yeşil/Green |
| CM102DH | 1 | 1 | - | √ | Siyah/Black |
| CM200DB | - | 1 | √ | √ | Beyaz/White |
| CM200DK | - | 1 | √ | √ | Kırmızı/Red |
| CM200DM | - | 1 | √ | √ | Mavi/Blue |
| CM200DS | - | 1 | √ | √ | Sarı/Yellow |
| CM200DY | - | 1 | √ | √ | Yeşil/Green |
| CM200DH | - | 1 | - | √ | Siyah/Black |
| CM202DB | - | 2 | √ | √ | Beyaz/White |
| CM202DK | - | 2 | √ | √ | Kırmızı/Red |
| CM202DM | - | 2 | √ | √ | Mavi/Blue |
| CM202DS | - | 2 | √ | √ | Sarı/Yellow |
| CM202DY | - | 2 | √ | √ | Yeşil/Green |
| CM202DH | - | 2 | - | √ | Siyah/Black |



CP100DM
Düz Kafalı Yaylı Buton
Round Push Button With Spring



CP100DK
Düz Kafalı Yaylı Buton
Round Push Button With Spring



CM 303DY
Düz Metal Kafalı Yaylı Buton (2NA+2NA)
Round Push Button With Spring and With Metallic Construction (2NO+2NO)



CM100DS
Düz Metal Kafalı Yaylı Buton
Round Push Button With Spring and With Metallic Construction



CM100DB
Düz Metal Kafalı Yaylı Buton
Round Push Button With Spring and With Metallic Construction

*: Işık Bloğu seçenekleri için bakınız sayfa 20 Kumanda Butonları Seçim Tablosu

*: See page 20 for illumination block selection - Push Buttons Selection Table

Kumanda Butonları

Push Buttons



CP200E30

ø 30 mm Şoklu Tip Acil Stop Butonu

Emergency Stop ø 30 mm, Twist On/Release On



CP200EA30

ø 30 mm Şoklu Tip Acil Stop Butonu

Emergency Stop ø 30 mm, Twist On/Release On



CM101DJ20

Joyistik Metal Kafalı Buton

Joystick Button With Metal Construction



CP102K20KY

Çiftli Düz Kafalı Yaylı Buton

Double Head Push Button



CM102K20HB

Çiftli Düz Metal Kafalı Buton

Double Head Push Button
With Metal Construction

C Serisi Ø 22 mm Adaptörlü Kumanda Butonu Tipleri

C Series Ø 22 mm Push Buttons With Adapter

| Sipariş Kodu Order Code | Kontakt Blok Tipi Contact Block Type | | Buton Tipi Button Type | | Renk Colour |
|----------------------------|---|----------------------------------|---------------------------|-----------------------|----------------|
| | Normal Açık Normally Open | Normal Kapalı Normally Closed | Sinyalli* With Signal* | Anahtarlı With Key | |
| CP200E30 | - | 1 | - | - | Kırmızı/Red |
| CP102E30 | 1 | 1 | - | - | Kırmızı/Red |
| CP100E30 | 1 | - | - | - | Kırmızı/Red |
| CP200EA30 | - | 1 | - | ✓ | Kırmızı/Red |
| CP200ES30 | - | 1 | ✓ | - | Kırmızı/Red |
| CP200ECN30 | - | 1 | - | - | Kırmızı/Red |
| CP200ECS30 | - | 1 | ✓ | - | Kırmızı/Red |

* : Standart olarak sinyal için kırmızı renkli led kullanılır, bkz. sayfa 20

* : See page 20, for signal standard colour is red.

Not : C serisi acil stop butonları ani kilitlemelidir (Şoklu Tip).

Note : C series emergency stop buttons have sudden locking feature (Twist On/Release On).

| Sipariş Kodu Order Code | Kontakt Blok Tipi Contact Block Type | | Pozisyon Position |
|----------------------------|---|----------------------------------|---|
| | Normal Açık Normally Open | Normal Kapalı Normally Closed | |
| CP101DJ20 | 2 | - | 2 Pozisyon-Kalıcı 2 Position-Stable |
| CP101DJ21 | 2 | - | 2 Pozisyon-Dönüşlü 2 Position-Rotational |
| CP707DJ40 | 4 | - | 4 Pozisyon-Kalıcı 4 Position-Stable |
| CP707DJ41 | 4 | - | 4 Pozisyon-Dönüşlü 4 Position-Rotational |
| CM101DJ20 | 2 | - | 2 Pozisyon-Kalıcı 2 Position-Stable |
| CM101DJ21 | 2 | - | 2 Pozisyon-Dönüşlü 2 Position-Rotational |
| CM707DJ40 | 4 | - | 4 Pozisyon-Kalıcı 4 Position-Stable |
| CM707DJ41 | 4 | - | 4 Pozisyon-Dönüşlü 4 Position-Rotational |



CP707DJ40

Joyistik Kafalı Buton



Joystick Button

| Sipariş Kodu Order Code | Kontakt Blok Tipi Contact Block Type | | Işık* Light | Buton Tipi Button Type | Renk Colour |
|----------------------------|---|----------------------------------|-------------------|---------------------------|------------------------------------|
| | Normal Açık Normally Open | Normal Kapalı Normally Closed | | | |
| CP102K20KY | 1 | 1 | ✓ Ledli Led | ✓ Düz Standard | Kırmızı/Yeşil-Mat Red/Green-Mat |
| CP102K20HB | 1 | 1 | ✓ | ✓ | Siyah/Beyaz-Mat Black/White-Mat |
| CM102K20KY | 1 | 1 | ✓ | ✓ | Kırmızı/Yeşil-Mat Red/Green-Mat |
| CM102K20HB | 1 | 1 | ✓ | ✓ | Siyah/Beyaz-Mat Black/White-Mat |

* : Işık Bloğu seçenekleri için bakınız sayfa 20 Kumanda Butonları Seçim Tablosu

* : See page 20 for illumination block selection - Push Buttons Selection Table

C Serisi Ø 22 mm Adaptörlü Kumanda Butonu Tipleri C Series Ø 22 mm Push Buttons With Adapter

| Sipariş Kodu Order Code | Kontakt Blok Tipi Contact Block Type | Işık* Light | Etiket Button Plates | Pozisyon Position |
|----------------------------|--|--|-------------------------|---|
| |  Normal Açık Normally Open |  Normal Kapalı Normally Closed | Ledli Led | |
| CP100S20 | 1 | - | √ | 0-I 2 Pozisyon-Kalıcılı 2 Position-Stable |
| CP101S30 | 2 | - | √ | II-0-I 3 Pozisyon-Kalıcılı 3 Position-Stable |
| CM100S20 | 1 | - | √ | 0-I 2 Pozisyon-Kalıcılı 2 Position-Stable |
| CM101S30 | 2 | - | √ | II-0-I 3 Pozisyon-Kalıcılı 3 Position-Stable |
| CP100S21 | 1 | - | √ | 0-I 2 Pozisyon-Dönüslü 2 Position-Rotational |
| CP101S31 | 2 | - | √ | II-0-I 3 Pozisyon-Tek Dönüslü 3 Position-Single Rotational |
| CP101S32 | 2 | - | √ | II-0-I 3 Pozisyon-Çift Dönüslü 3 Position-Double Rotational |
| CM100S21 | 1 | - | √ | 0-I 2 Pozisyon-Dönüslü 2 Position-Rotational |
| CM101S31 | 2 | - | √ | II-0-I 3 Pozisyon-Tek Dönüslü 3 Position-Single Rotational |
| CM101S32 | 2 | - | √ | II-0-I 3 Pozisyon-Çift Dönüslü 3 Position-Double Rotational |

*: Işık Bloğu seçenekleri için bakınız sayfa 22 Kumanda Butonları Seçim Tablosu

*: See page 22 for illumination block selection - Push Buttons Selection Table

| Sipariş Kodu Order Code | Işık* Light | Nominal Gerilim Nominal Voltage | Renk Colour |
|----------------------------|----------------|------------------------------------|----------------|
| | Ledli Led | | |
| CP050XB | 1 | 12-30 V AC/DC | Beyaz/White |
| CP060XK | 1 | 12-30 V AC/DC | Kırmızı/Red |
| CP070XM | 1 | 12-30 V AC/DC | Mavi/Blue |
| CP080XS | 1 | 12-30 V AC/DC | Sarı/Yellow |
| CP090XY | 1 | 12-30 V AC/DC | Yeşil/Green |
| CP0B0XB | 1 | 100-230 V AC | Beyaz/White |
| CP0K0XK | 1 | 100-230 V AC | Kırmızı/Red |
| CP0M0XM | 1 | 100-230 V AC | Mavi/Blue |
| CP0S0XS | 1 | 100-230 V AC | Sarı/Yellow |
| CP0Y0XY | 1 | 100-230 V AC | Yeşil/Green |
| CM050XB | 1 | 12-30 V AC/DC | Beyaz/White |
| CM060XK | 1 | 12-30 V AC/DC | Kırmızı/Red |
| CM070XM | 1 | 12-30 V AC/DC | Mavi/Blue |
| CM080XS | 1 | 12-30 V AC/DC | Sarı/Yellow |
| CM090XY | 1 | 12-30 V AC/DC | Yeşil/Green |
| CM0B0XB | 1 | 100-230 V AC | Beyaz/White |
| CM0K0XK | 1 | 100-230 V AC | Kırmızı/Red |
| CM0M0XM | 1 | 100-230 V AC | Mavi/Blue |
| CM0S0XS | 1 | 100-230 V AC | Sarı/Yellow |
| CM0Y0XY | 1 | 100-230 V AC | Yeşil/Green |

*: Işık Bloğu seçenekleri için bakınız sayfa 20 Kumanda Butonları Seçim Tablosu

*: See page 20 for illumination block selection - Push Buttons Selection Table



CM101S30

Metal Kafalı Seçici Buton, II-0-I

Selector Switch With Metal Construction



CP100S20

Seçici Buton, 0-I

Selector Switch



CP 305S30

Seçici Buton II-0-I (2NA+2NC)

Selector Switch (2NO+2NC)



CP080XS

Sinyal Lambası ø 22 mm

Signal Lamp ø 22 mm



CM060XK

Metal Kafalı Sinyal Lambası ø 22 mm

Signal Lamp ø 22 mm With Metal Construction

Kumanda Butonları

Push Buttons



C Serisi Kontak Bloklar ve Işık Blokları / Contact Block Types For C Series ø 22 mm Push Buttons With Adapter

C Serisi Butonluk / C Series For Buttons

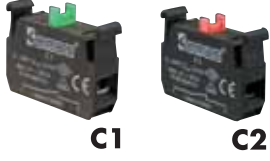

C1
C Serisi Butonluk
Kontakt Blok Start-Stop
C Series For Button
Contact Block Start-Stop



CBM
C Serisi Butonluk Ledli Blok
C Series For Button
Illumination Block With Led

| Sipariş Kodu Order Code | Kontakt Blok Tipi Contact Block Type | | Işık Light | Nominal Akım Nominal Current | Nominal Gerilim Nominal Voltage | Renk Colour |
|----------------------------|---|----------------------------------|---------------|---------------------------------|------------------------------------|----------------|
| | Normal Açık Normally Open | Normal Kapalı Normally Closed | | | | |
| C1 | 1 | - | - | 4A | 250 V | - |
| C2 | - | 1 | - | 4A | 250 V | - |
| CB5 | - | - | 1 | 5-15mA | 12-30 V AC/DC | Beyaz/White |
| CB6 | - | - | 1 | 5-15mA | 12-30 V AC/DC | Kırmızı/Red |
| CB7 | - | - | 1 | 5-15mA | 12-30 V AC/DC | Mavi/Blue |
| CB8 | - | - | 1 | 5-15mA | 12-30 V AC/DC | Sarı/Yellow |
| CB9 | - | - | 1 | 5-15mA | 12-30 V AC/DC | Yeşil/Green |
| CBB | - | - | 1 | 2-5mA | 100-230 V AC | Beyaz/White |
| CBK | - | - | 1 | 2-5mA | 100-230 V AC | Kırmızı/Red |
| CBM | - | - | 1 | 2-5mA | 100-230 V AC | Mavi/Blue |
| CBS | - | - | 1 | 2-5mA | 100-230 V AC | Sarı/Yellow |
| CBY | - | - | 1 | 2-5mA | 100-230 V AC | Yeşil/Green |
| CBB-4 | - | - | 1 | 4-5mA | 110 V AC/DC | Beyaz/White |
| CBK-4 | - | - | 1 | 4-5mA | 110 V AC/DC | Kırmızı/Red |
| CBM-4 | - | - | 1 | 4-5mA | 110 V AC/DC | Mavi/Blue |
| CBS-4 | - | - | 1 | 4-5mA | 110 V AC/DC | Sarı/Yellow |
| CBY-4 | - | - | 1 | 4-5mA | 110 V AC/DC | Yeşil/Green |

Not : Maksimum 3 adet kontak blok arka arkaya eklenebilir.
Note : Max. 3 contact blocks can be added subsequently.

C Serisi Kutuluk / C Series For Boxes



C3
C Serisi Kutuluk
Kontakt Blok Start-Stop
C Series For Box
Contact Block Start-Stop



CK7
C Serisi Kutuluk Ledli Blok
C Series For Box
Illumination Block With Led

| Sipariş Kodu Order Code | Kontakt Blok Tipi Contact Block Type | | Işık Light | Nominal Akım Nominal Current | Nominal Gerilim Nominal Voltage | Renk Colour |
|----------------------------|---|----------------------------------|---------------|---------------------------------|------------------------------------|----------------|
| | Normal Açık Normally Open | Normal Kapalı Normally Closed | | | | |
| C3 | 1 | - | - | 4A | 250 V | - |
| C4 | - | 1 | - | 4A | 250 V | - |
| C3CK | 1 | - | - | 4A | 250 V | - |
| C4CK | - | 1 | - | 4A | 250 V | - |
| C3BK | 1 | - | - | 4A | 250 V | - |
| C4BK | - | 1 | - | 4A | 250 V | - |
| CK5 | - | - | 1 | 5-15mA | 12-30 V AC/DC | Beyaz/White |
| CK6 | - | - | 1 | 5-15mA | 12-30 V AC/DC | Kırmızı/Red |
| CK7 | - | - | 1 | 5-15mA | 12-30 V AC/DC | Mavi/Blue |
| CK8 | - | - | 1 | 5-15mA | 12-30 V AC/DC | Sarı/Yellow |
| CK9 | - | - | 1 | 5-15mA | 12-30 V AC/DC | Yeşil/Green |
| CKB | - | - | 1 | 2-5mA | 100-230 V AC | Beyaz/White |
| CKK | - | - | 1 | 2-5mA | 100-230 V AC | Kırmızı/Red |
| CKM | - | - | 1 | 2-5mA | 100-230 V AC | Mavi/Blue |
| CKS | - | - | 1 | 2-5mA | 100-230 V AC | Sarı/Yellow |
| CKY | - | - | 1 | 2-5mA | 100-230 V AC | Yeşil/Green |
| CKB-4 | - | - | 1 | 4-5mA | 110 V AC/DC | Beyaz/White |
| CKK-4 | - | - | 1 | 4-5mA | 110 V AC/DC | Kırmızı/Red |
| CKM-4 | - | - | 1 | 4-5mA | 110 V AC/DC | Mavi/Blue |
| CKS-4 | - | - | 1 | 4-5mA | 110 V AC/DC | Sarı/Yellow |
| CKY-4 | - | - | 1 | 4-5mA | 110 V AC/DC | Yeşil/Green |

Aksesuarlar / Accessories

| Sipariş Kodu Order Code | Malzeme Material | Renk Colour |
|----------------------------|---------------------|----------------|
| CMB | Metal/Metal | Sarı/Yellow |
| B-ROZET08 | Plastik/Plastic | Siyah/Black |
| B-ROZET18 | Plastik/Plastic | Siyah/Black |
| B-MUHAFAZA | Plastik/Plastic | Sarı/Yellow |



CMB

Montaj Bileziği
Mounting Bracelet



B-ROZET18

Rozet 18 mm
Badge Base 18 mm



B-ROZET08

Rozet 8 mm
Badge Base 8 mm



BET60P (Plastik/Plastic)

BET60A (Alüminyum/Aluminium)

Etiket ø 60 mm Acil Stop
Plate ø 60 mm Emergency Stop



BET90P (Plastik/Plastic)

BET90A (Alüminyum/Aluminium)

Etiket ø 90 mm Acil Stop
Plate ø 90 mm Emergency Stop



B-MUHAFAZA

Emniyet Basma Düğmesi
Darbe Muhafazası
Emergency Push Button
Plate Protection

| Sipariş Kodu Order Code | Etiket Yazısı Plate | Renk Colour |
|----------------------------|------------------------|-----------------------------------|
| BET08 | - | Gri/Grey |
| BET18 | - | Gri/Grey |
| BET08-START | START | Gri/Grey |
| BET08-STOP | STOP | Gri/Grey |
| BET08-01 | O-I | Gri/Grey |
| BET08-01OK | O-I | Gri/Grey |
| BET08-201 | II-O-I | Gri/Grey |
| BET08-201OK | II-O-I | Gri/Grey |
| BET08-201OK2 | II-O-I | Gri/Grey |
| BET60P | EMERGENCY STOP | Sarı/Yellow - Plastik/Plastic |
| BET90P | EMERGENCY STOP | Sarı/Yellow - Plastik/Plastic |
| BET60A | EMERGENCY STOP | Sarı/Yellow - Alüminyum/Aluminium |
| BET90A | EMERGENCY STOP | Sarı/Yellow - Alüminyum/Aluminium |



BET18

Etiket 18 mm Boş
Plate 18 mm Empty



BET08

Etiket 8 mm Boş
Plate 8 mm Empty



BET08-START

Etiket 8 mm START
Plate 8 mm START



BET08-STOP

Etiket 8 mm STOP
Plate 8 mm STOP



BET201-OK2

Etiket 8 mm II-O-I
Plate 8 mm II-O-I



BET201-OK

Etiket 8 mm II-O-I
Plate 8 mm II-O-I



BET201

Etiket 8 mm II-O-I
Plate 8 mm II-O-I



BET01-OK

Etiket 8 mm O-I
Plate 8 mm O-I



BET01

Etiket 8 mm O-I
Plate 8 mm O-I

Kumanda Butonları

Push Buttons



Montaj Şekli / Assembly

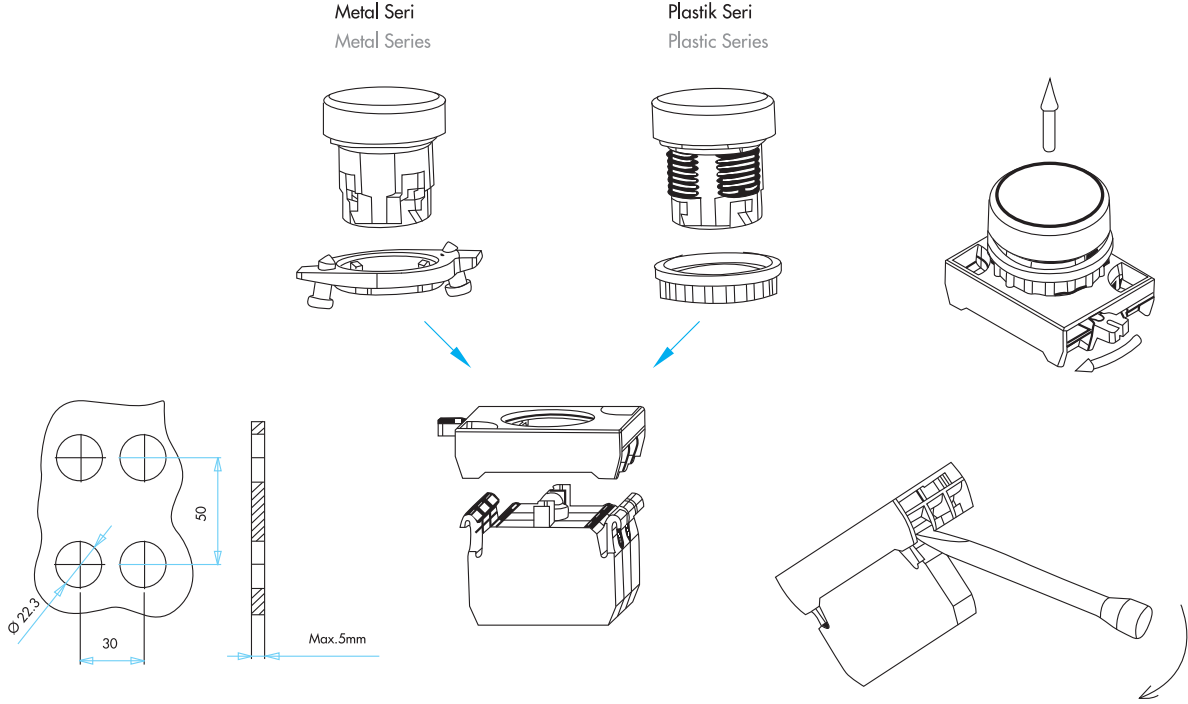

Emniyet ve mantar butonlarında 30 mm ölçüsü 45 mm'dir.
30 mm size is 45 mm in emergency and mushroom buttons.

Boyutlar (mm) / Dimensions (mm)

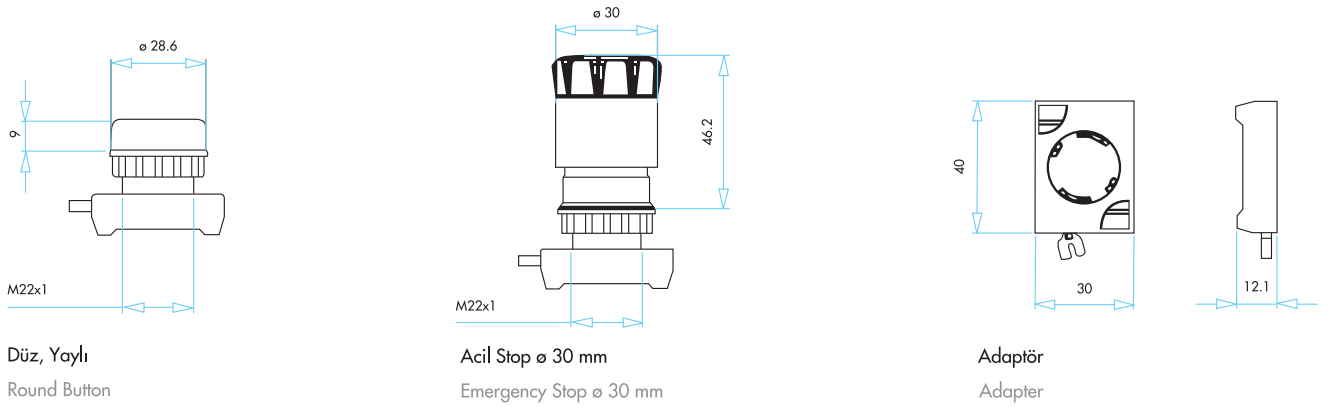

Boyutlar (mm) / Dimensions (mm)

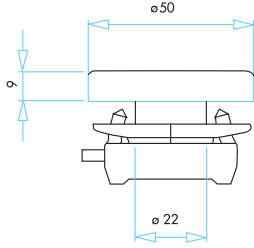

Çiftli Düz Kafalı, Yaylı
Double Head With Spring

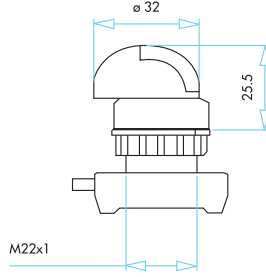

Seçici
Selector

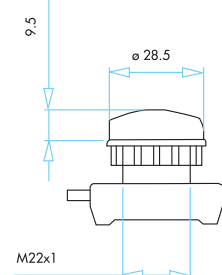

Sinyal
Signal

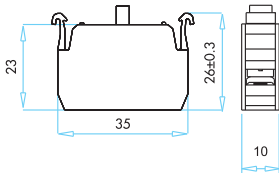

C Serisi Kontak
Blok-Butonluk
C Series Contact
Block-For Button

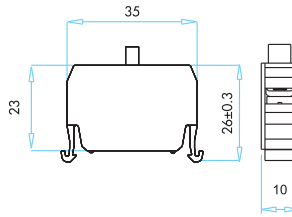

C Serisi Kontak
Blok-Kutuluk
C Series Contact
Block-For Box

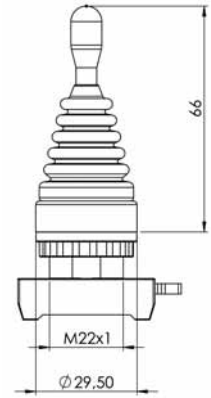

Joyistik
Joystick

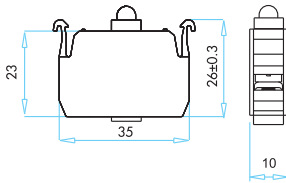

C Serisi Ledli
Işıklı Blok-Butonluk
C Series Illumination
Block With Led-For Button

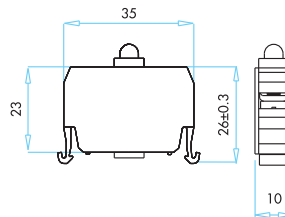

C Serisi Ledli
Işıklı Blok-Kutuluk
C Series Illumination
Block With Led-For Box



MB Serisi Ø 22 mm Monoblok Kumanda Butonları

- Yekpare gövde
- Darbelere dayanıklı polikarbonat basma düğmesi
- Can güvenliği açısından korumalı kablo giriş uçları.
- Rozet ve etiket çeşitleri ile konumlandırma imkanı.
- Tüm uygulamalara cevap verecek ürün çeşitliliği.

Teknik Bilgiler

| | |
|--------------------------------|---|
| Mekanik Ömür | : 500.000 açma-kapama min. |
| Elektriksel Ömür | : 100.000 açma-kapama min. |
| Çalışma Sıcaklığı | : min./maks. °C -5/+40 |
| Koruma Sınıfı | : IP40 = Ürün; pano veya kutuda ise |
| Anma İşletme Gerilimi Ue | : 240 V AC |
| Anma İşletme Akımı Ie | : 0.3 A AC |
| Anma Kesme Kapasitesi AC 15 | : 1 kA |
| Yalıtım Gerilimi Ui | : 250 V |
| Darbe Dayanım Gerilimi Uimp | : 2,5 kV |
| Standart Kontak Malzemesi | : AgNi |
| İzolasyon Direnci | : 10 MΩ min. (500 V DC) |
| Kullanım Sınıfı | : AC 14 |
| Dielektrik Mukavemeti | : Gövde-Kontak arası 2500 V AC Açık Kontak 1500 V AC |
| Bağlantı Kablo Kesiti Standart | : 1.5-2.5 mm ² : IEC 947 / EN60947-5-1 |



MB Series Ø 22 mm Monoblock Push Buttons

- Monoblock body
- Wide product range satisfying all requirements
- Strong polycarbonate button. Protective cable inlet tips enabling maximum safety.
- Position facility with badge and label kinds. Product variety fulfilling of all applications

Technical Information

| | |
|---|--|
| Mechanical Life | : 500.000 operations min. |
| Electrical Life | : 100.000 operations min. |
| Operating Temperature | : min./max. °C -5/+40 |
| Protection Degree | : IP40 = If the product is in panel or in box |
| Rated Operating Voltage Ue | : 240 V AC |
| Rated Operating Current Ie | : 0.3 A AC |
| Switching Power in AC 15 | : 1 kA |
| Insulation Voltage Ui | : 250 V |
| Stroke Resistance Voltage Uimp | : 2,5 kV |
| Standard Contact Material | : AgNi |
| Insulation Resistance | : 10 MΩ min. (500 V DC) |
| Operating Class | : AC 14 |
| Dielectrical Strength | : Between body-contact 2500 V AC Open contact 1500 V AC |
| Connection Cable Cross-Section Standard | : 1.5-2.5 mm ² : IEC 947 / EN60947-5-1 |



MB Serisi Monoblok Kumanda Butonları Seçim Tablosu

Series Monoblock Push Buttons Selection Table

| Seri | Kontakt Kombinasyonu | | | Buton Tipi | Renk |
|---|---|---|---|--|--|
| MB | 1 | 0 | 2 | D | K |
| Series | Contact Combination | | | Button Type | Colour |
| MB MB Serisi Ø 22 mm Kumanda Butonu MB Series Ø 22 mm Push Button | Kontakt Tipi Contact Type 1 Start 2 Stop | Kontakt Tipi Contact Type 1 Start 2 Stop | Kontakt Tipi Contact Type 1 Start 2 Stop | Yaylı Tip Butonlar Stringed Type Buttons D Düz, Yuvarlak Round Seçici Tip Butonlar Selector Switch Type Buttons S20 Seçici, 2 Pozisyonlu, Kalıcı (0-I) ↘ Selector Switch, 2 Position, Stable (0-I) S21 Seçici, 2 Pozisyonlu, Dönüşlü (0-I) ↗ Selector Switch, 2 Position, Rotational (0-I) S30 Seçici, 3 Pozisyonlu, Kalıcı (II-0-I) ↘ Selector Switch, 3 Position, Stable (II-0-I) S31 Seçici, 3 Pozisyonlu, Tek Dönüşlü (II-0-I) ↗ Selector Switch, 3 Position, Single Rotational (II-0-I) S32 Seçici, 3 Pozisyonlu, Çift Dönüşlü (II-0-I) ↗↘ Selector Switch, 3 Position, Double Rotational (II-0-I) | Buton Rengi Button Colour B Beyaz White K Kırmızı Red M Mavi Blue S Sarı Yellow Y Yeşil Green H Siyah Mat Black Mat |
| | | | | Monoblok Mantar Butonları Monoblock Mushroom Buttons M Ø 40 mm Monoblok Mantar Buton Ø 40 mm Monoblock Mushroom Button | |
| | | | | Acil Stop Butonları Emergency Stop Buttons E Acil Stop Ø 40 mm Emergency Stop Ø 40 mm | |

Örnek: MB102DY → Örnek olarak, MB serisi, start-stop, düz yaylı tip yeşil buton

Example: MB102DY → For example, MB series, start-stop, flat type, green push button.

Kumanda Butonları

Push Buttons



MB Serisi Ø 22 mm Monoblok Kumanda Butonu Tipleri
MB Series Ø 22 mm Monoblock Push Button Types

| Sipariş Kodu Order Code | Kontakt Blok Tipi Contact Block Type | | Renk Colour |
|----------------------------|---|----------------------------------|----------------|
| | Normal Açık Normally Open | Normal Kapalı Normally Closed | |
| MB100DB | 1 | - | Beyaz/White |
| MB100DK | 1 | - | Kırmızı/Red |
| MB100DM | 1 | - | Mavi/Blue |
| MB100DS | 1 | - | Sarı/Yellow |
| MB100DY | 1 | - | Yeşil/Green |
| MB100DH | 1 | - | Siyah/Black |
| MB101DB | 2 | - | Beyaz/White |
| MB101DK | 2 | - | Kırmızı/Red |
| MB101DM | 2 | - | Mavi/Blue |
| MB101DS | 2 | - | Sarı/Yellow |
| MB101DY | 2 | - | Yeşil/Green |
| MB101DH | 2 | - | Siyah/Black |
| MB102DB | 1 | 1 | Beyaz/White |
| MB102DK | 1 | 1 | Kırmızı/Red |
| MB102DM | 1 | 1 | Mavi/Blue |
| MB102DS | 1 | 1 | Sarı/Yellow |
| MB102DY | 1 | 1 | Yeşil/Green |
| MB102DH | 1 | 1 | Siyah/Black |
| MB200DB | - | 1 | Beyaz/White |
| MB200DK | - | 1 | Kırmızı/Red |
| MB200DM | - | 1 | Mavi/Blue |
| MB200DS | - | 1 | Sarı/Yellow |
| MB200DY | - | 1 | Yeşil/Green |
| MB200DH | - | 1 | Siyah/Black |
| MB202DB | - | 2 | Beyaz/White |
| MB202DK | - | 2 | Kırmızı/Red |
| MB202DM | - | 2 | Mavi/Blue |
| MB202DS | - | 2 | Sarı/Yellow |
| MB202DY | - | 2 | Yeşil/Green |
| MB202DH | - | 2 | Siyah/Black |



MB 102DY

Düz Kafalı Yaylı Buton
Round Push Button



MB 102DK

Düz Kafalı Yaylı Buton
Round Push Button



MB 102DS

Düz Kafalı Yaylı Buton
Round Push Button

| Sipariş Kodu Order Code | Kontakt Blok Tipi Contact Block Type | | Etiket Button Plates | Pozisyon Position |
|----------------------------|---|----------------------------------|-------------------------|---|
| | Normal Açık Normally Open | Normal Kapalı Normally Closed | | |
| MB100S20 | 1 | - | O-I | 2 Pozisyon - Kalkıcı 2 Position - Stable |
| MB100S21 | 1 | - | O-I | 2 Pozisyon - Dönüşlü 2 Position - Rotational |
| MB101S30 | 2 | - | II-O-I | 3 Pozisyon - Kalkıcı 3 Position - Stable |
| MB101S31 | 2 | - | II-O-I | 3 Pozisyon - Tek Dönüşlü 3 Position - Rotational |
| MB101S32 | 2 | - | II-O-I | 3 Pozisyon - Çift Dönüşlü 3 Position - Unfixable |



MB 102S30

Seçici Buton
Selector Switch

MB Serisi Ø 22 mm Monoblok Acil Stop Butonu Tipleri MB Series Ø 22 mm Monoblock Emergency Button Types

| Sipariş Kodu Order Code | Kontakt Blok Tipi Contact Block Type | | Renk Colour |
|----------------------------|---|----------------------------------|----------------|
| | Normal Açık Normally Open | Normal Kapalı Normally Closed | |
| MB100E | 1 | - | Kırmızı/Red |
| MB101E | 2 | - | Kırmızı/Red |
| MB102E | 1 | 1 | Kırmızı/Red |
| MB200E | - | 1 | Kırmızı/Red |
| MB202E | - | 2 | Kırmızı/Red |



MB102E
40 mm Acil Stop Butonu
40 mm Emergency Stop

MB Serisi Ø 22 mm Monoblok Mantar Buton Tipleri MB Series Ø 22 mm Monoblock Mushroom Button Types

| Sipariş Kodu Order Code | Kontakt Blok Tipi Contact Block Type | | Renk Colour |
|----------------------------|---|----------------------------------|----------------|
| | Normal Açık Normally Open | Normal Kapalı Normally Closed | |
| MB100MY | 1 | - | Yeşil/Green |
| MB101MY | 2 | - | Yeşil/Green |
| MB102MK | 1 | 1 | Kırmızı/Red |
| MB200MK | - | 1 | Kırmızı/Red |
| MB202MK | - | 2 | Kırmızı/Red |



MB102MK
40 mm Mantar Buton
40 mm Mushroom Button

MB Serisi Ø 22 mm Monoblok Sinyal Tipleri (LED'li) MB Series Ø 22 mm Monoblock Signal Types (LED Bulb)

| | | Sipariş Kodu Order Code | | | | |
|---------------------------|-------|-------------------------|---------------|---------------|---------------|---------------|
| DÜZ CAM FLAT GLASS | 24 V | MBS D 024 (B) | MBS D 024 (K) | MBS D 024 (M) | MBS D 024 (Y) | MBS D 024 (S) |
| | 230 V | MBS D 220 (B) | MBS D 220 (K) | MBS D 220 (M) | MBS D 220 (Y) | MBS D 220 (S) |
| PETEKLİ CAM COMB GLASS | 24 V | MBS P 024 (B) | MBS P 024 (K) | MBS P 024 (M) | MBS P 024 (Y) | MBS P 024 (S) |
| | 230 V | MBS P 220 (B) | MBS P 220 (K) | MBS P 220 (M) | MBS P 220 (Y) | MBS P 220 (S) |



MBS D 024Y



MBS P 024Y

Kumanda Butonları

Push Buttons



BEB

ø 22 mm Etanj Başlık
ø 22 mm Waterproof Cover



B-ROZET08

Rozet 8 mm
Badge Base 8 mm



B-ROZET18

Rozet 18 mm
Badge Base 18 mm



B-MUHAFAZA

Emniyet Basma Düğmesi
Darbe Muhafazası
Emergency Push Button
Plate Protection



B-PUL

Buton Sıkıştırma Pulu
Push Button Fixing Plate



BET18

Etiket 18 mm Boş
Plate 18 mm Empty



BET08

Etiket 8 mm Boş
Plate 8 mm Empty

START

BET08-START

Etiket 8 mm START
Plate 8 mm START

STOP

BET08-STOP

Etiket 8 mm STOP
Plate 8 mm STOP

O I

BET01

Etiket 8 mm O-I
Plate 8 mm O-I

O I

BET01-OK

Etiket 8 mm O-I
Plate 8 mm O-I

II O I

BET201

Etiket 8 mm II-O-I
Plate 8 mm II-O-I

II O I

BET201-OK

Etiket 8 mm
Plate 8 mm

II O I

BET201-OK2

Etiket 8 mm II-O-I
Plate 8 mm II-O-I



BET60P (Plastik/Plastic) BET60A (Alüminyum/Aluminium)

Etiket ø 60 mm Acil Stop
Plate ø 60 mm Emergency Stop



BET90P (Plastik/Plastic) BET90A (Alüminyum/Aluminium)

Etiket ø 90 mm Acil Stop
Plate ø 90 mm Emergency Stop

Aksesuarlar / Accessories

| Sipariş Kodu Order Code | Malzeme Material | Renk Colour |
|----------------------------|--|--------------------|
| BEB | Silikon/Silicon | Şeffaf/Transparent |
| B-ROZET08 | Plastik/Plastic | Siyah/Black |
| B-ROZET18 | Plastik/Plastic | Siyah/Black |
| B-MUHAFAZA | Plastik/Plastic | Sarı/Yellow |
| B-PUL | Paslanmaz Sac/Non Corrosive Iron Sheet | Gri/Grey |

| Sipariş Kodu Order Code | Etiket Yazısı Plate | Renk Colour |
|----------------------------|------------------------|-----------------------------------|
| BET08 | - | Gri/Grey |
| BET18 | - | Gri/Grey |
| BET08-START | START | Gri/Grey |
| BET08-STOP | STOP | Gri/Grey |
| BET08-01 | O-I | Gri/Grey |
| BET08-01OK | O-I | Gri/Grey |
| BET08-201 | II-O-I | Gri/Grey |
| BET08-201OK | II-O-I | Gri/Grey |
| BET08-201OK2 | II-O-I | Gri/Grey |
| BET60P | EMERGENCY STOP | Sarı/Yellow |
| BET90P | EMERGENCY STOP | Sarı/Yellow |
| BET60A | EMERGENCY STOP | Sarı/Yellow - Alüminyum/Aluminium |
| BET90A | EMERGENCY STOP | Sarı/Yellow - Alüminyum/Aluminium |

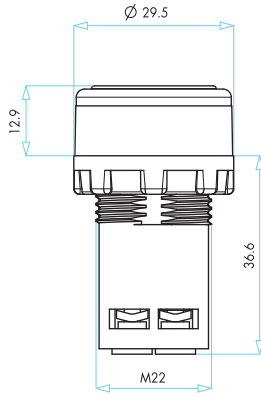

Düz Kafalı Yaylı Buton
Round Push Button

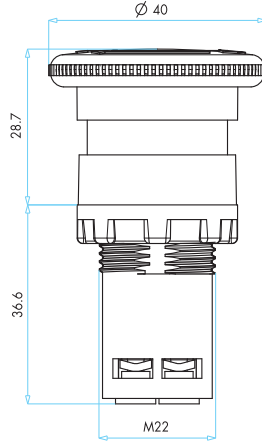

40 mm Acil Stop Butonu
40 mm Emergency Stop

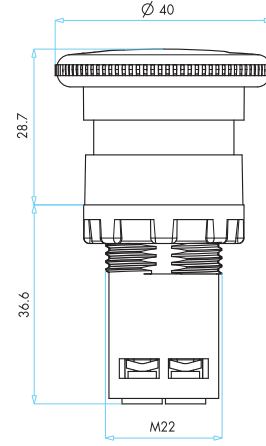

40 mm Mantar Buton
40 mm Mushroom Button

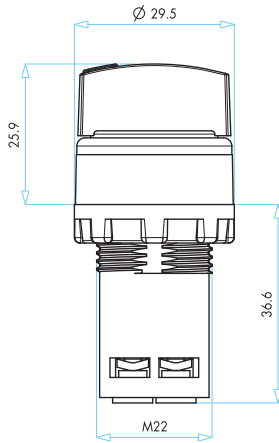

Seçici Buton
Selector Switch

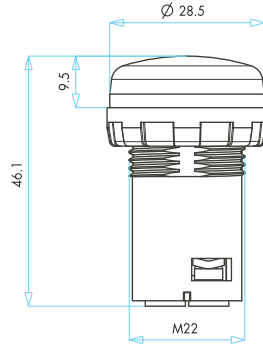

Sinyal (Petekli Cam)
Signal (Comb Glass)

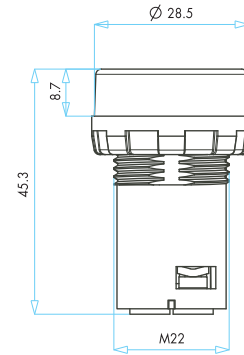

Sinyal (Düz Cam)
Signal (Flat Glass)